

# ioLogik 2500 Series User's Manual

---

Edition 6.2, April 2017

[www.moxa.com/product](http://www.moxa.com/product)

**MOXA**®

© 2017 Moxa Inc. All rights reserved.

# ioLogik 2500 Series User's Manual

The software described in this manual is furnished under a license agreement and may be used only in accordance with the terms of that agreement.

## Copyright Notice

© 2017 Moxa Inc. All rights reserved.

## Trademarks

The MOXA logo is a registered trademark of Moxa Inc.  
All other trademarks or registered marks in this manual belong to their respective manufacturers.

## Disclaimer

Information in this document is subject to change without notice and does not represent a commitment on the part of Moxa.

Moxa provides this document as is, without warranty of any kind, either expressed or implied, including, but not limited to, its particular purpose. Moxa reserves the right to make improvements and/or changes to this manual, or to the products and/or the programs described in this manual, at any time.

Information provided in this manual is intended to be accurate and reliable. However, Moxa assumes no responsibility for its use, or for any infringements on the rights of third parties that may result from its use.

This product might include unintentional technical or typographical errors. Changes are periodically made to the information herein to correct such errors, and these changes are incorporated into new editions of the publication.

## Technical Support Contact Information

[www.moxa.com/support](http://www.moxa.com/support)

### Moxa Americas

Toll-free: 1-888-669-2872  
Tel: +1-714-528-6777  
Fax: +1-714-528-6778

### Moxa Europe

Tel: +49-89-3 70 03 99-0  
Fax: +49-89-3 70 03 99-99

### Moxa India

Tel: +91-80-4172-9088  
Fax: +91-80-4132-1045

### Moxa China (Shanghai office)

Toll-free: 800-820-5036  
Tel: +86-21-5258-9955  
Fax: +86-21-5258-5505

### Moxa Asia-Pacific

Tel: +886-2-8919-1230  
Fax: +886-2-8919-1231

# Table of Contents

<b>1. Overview</b>	<b>1-1</b>
ioLogik 2500 Overview	1-2
Appearance	1-2
Dimensions Diagram	1-3
Package Checklist	1-3
Product Features	1-3
I/O Channels Available on ioLogik 2500 Models	1-3
Communication Interface	1-4
ioLogik 2500 Ethernet Series Specifications	1-4
Common Specifications	1-4
ioLogik 2512 Ethernet Specifications	1-5
ioLogik 2542 Ethernet Specifications	1-6
ioLogik 2500 HSPA/GPRS/WLAN Series Specifications	1-7
Common Specifications	1-7
ioLogik 2512 HSPA/GPRS/WLAN Specifications	1-8
ioLogik 2542 HSPA/GPRS/WLAN Specifications	1-9
<b>2. Installation</b>	<b>2-1</b>
Hardware Installation	2-2
Installing the ioLogik 2500 on a DIN Rail	2-2
Removing the ioLogik 2500 from a DIN Rail	2-2
Powering on the ioLogik 2500	2-3
Grounding the Unit	2-3
Installing a microSD Card and SIM Cards (cellular models only)	2-3
I/O Wiring Diagrams	2-4
LED Indicators	2-4
Daisy-Chaining for I/O Expansion	2-5
Reset to Factory Defaults	2-6
Network Installation	2-6
Ethernet Communication	2-6
TCP/IP Settings	2-6
Serial Communication	2-7
Software Installation—IOxpress Utility	2-7
System Requirements	2-8
Installing IOxpress	2-8
<b>3. The IOxpress Utility</b>	<b>3-1</b>
Application Interface	3-2
Main screen	3-2
Menu Bar	3-2
Using IOxpress	3-3
Configuration Flowchart	3-3
Offline Configuration Management	3-3
Online Device Management	3-3
<b>4. Offline Configuration Management</b>	<b>4-1</b>
Introduction	4-2
Saving Configurations as a Project	4-2
Adding an ioLogik 2500 Device to a Project	4-2
Adding E1200 I/O Expansion Modules to a Project	4-2
Setting Up a Device	4-4
Settings Tab	4-4
System	4-4
Security	4-5
Network	4-6
I/O	4-8
SNMP	4-17
Modbus	4-18
AOPC	4-19
Serial Port (Port1/Port2)	4-21
Data Logging	4-24
Click&Go Plus	4-27
Click&Go Plus Tab	4-27
Click&Go Plus Simulator Tab	4-28
Peer-to-Peer Tab	4-28
General Settings	4-29
Peer-to-Peer Rule Settings	4-29
<b>5. Online Device Management</b>	<b>5-1</b>
Introduction	5-2
Auto-Searching for Online Devices	5-3

First Time Searching for Devices .....	5-3
Conducting another Search for Online Devices .....	5-3
Adding Devices Manually .....	5-4
Add Device by IP Address .....	5-4
Add Device by Cellular Data Access .....	5-5
Mass Deployment .....	5-6
Update Configuration to Device .....	5-7
Get Configuration from Device .....	5-7
Update Firmware.....	5-7
Time Sync .....	5-8
Retrieve System Log.....	5-8
Restart Device .....	5-8
Load Factory Default.....	5-8
Change IP Address .....	5-8
Change Server Name.....	5-8
Web Console .....	5-8
Web Console Functions.....	5-9
User Interface Introduction.....	5-9
System Information Panel .....	5-10
Menu Panel and Web Pages .....	5-10
<b>6. Cellular Network Setup and Configuration (for cellular models) .....</b>	<b>6-1</b>
IOxpress Settings for a Cellular Network.....	6-2
Select Network Interface .....	6-2
Cellular .....	6-3
Cellular Network Connection .....	6-10
MX-AOPC Server (for SCADA/HMI users).....	6-10
With DDNS (for SCADA/HMI users).....	6-11
Moxa Cellular Data Access Utility (for mobile devices/PCs).....	6-11
<b>7. Wireless LAN Network Setup and Configuration (for wireless LAN models) .....</b>	<b>7-1</b>
Deploying the ioLogik 2500-WL1 .....	7-2
IOxpress Settings for a Wireless LAN Network .....	7-2
Wireless LAN .....	7-2
<b>A. Network Port Usage .....</b>	<b>A-1</b>

The ioLogik 2500 is a smart remote I/O product with unique hardware and software designs, making it an ideal solution for a variety of industrial data acquisition applications. The ioLogik 2500's hardware design includes a 4-port unmanaged Ethernet switch and 2 serial ports, enabling the ioLogik 2500 to seamlessly connect to a variety of field devices. One of the Ethernet ports can be used to link to 8 daisy-chained ioLogik E1200 expansion modules to provide more than 100 channels. The ioLogik 2500 acts as the "head" unit, with Click&Go Plus logic used to control the entire I/O array. Most importantly, the ioLogik 2500's single IP is all that's required to connect the entire I/O array to your network, providing the perfect solution for industrial field sites that have an insufficient number of IP addresses.

For cellular connections, the ioLogik 2500 supports Moxa's patented MX-AOPC Server with push communications technology, and provides an economical solution for accessing multiple remote I/O devices connected to the same private IP network, which itself links to the outside world over a cellular connection using dynamic IP addresses.

The following topics are covered in this chapter:

#### ▣ **ioLogik 2500 Overview**

- Appearance
- Dimensions Diagram
- Package Checklist
- Product Features
- I/O Channels Available on ioLogik 2500 Models
- Communication Interface

#### ▣ **ioLogik 2500 Ethernet Series Specifications**

- Common Specifications
- ioLogik 2512 Ethernet Specifications
- ioLogik 2542 Ethernet Specifications

#### ▣ **ioLogik 2500 HSPA/GPRS/WLAN Series Specifications**

- Common Specifications
- ioLogik 2512 HSPA/GPRS/WLAN Specifications
- ioLogik 2542 HSPA/GPRS/WLAN Specifications

# ioLogik 2500 Overview



The ioLogik 2500 combines a remote I/O device and data logger into one box, dramatically reducing the amount of effort required to integrate devices from multiple vendors. I/O and serial data can be logged onto a Micro SD card (supports cards with up to 32 GB of storage space), and the ioLogik 2500 can be programmed with Moxa's convenient Click&Go™ Plus control logic, which can be used to easily construct customized control systems. As a rugged industrial device, the ioLogik 2500 operates reliably at a wide range of temperatures, and is well suited for hard-to-wire remote monitoring and alarm applications at unmanned sites like riversides and pipelines.

## Appearance

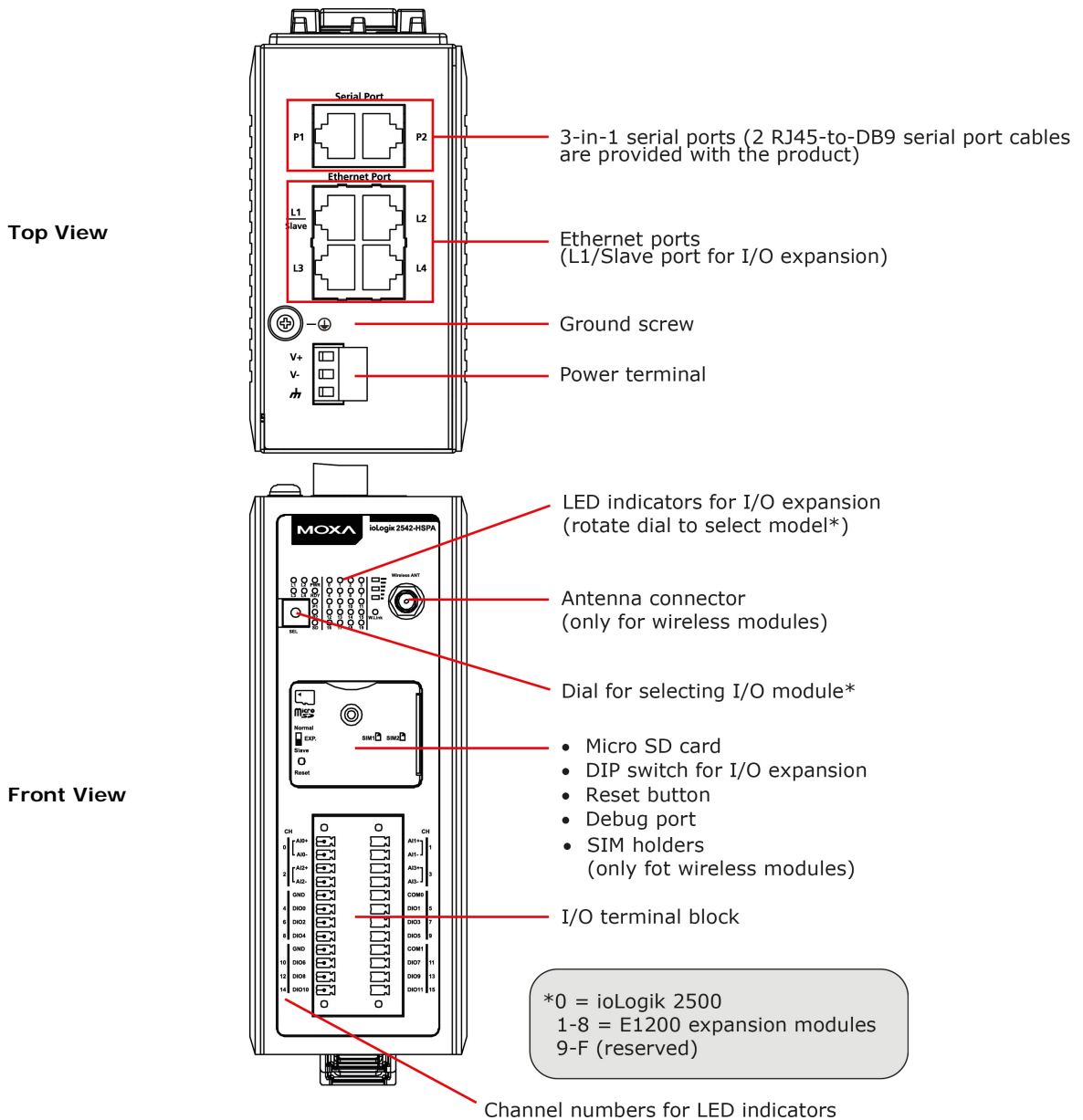

## Dimensions Diagram

Units: mm (in)

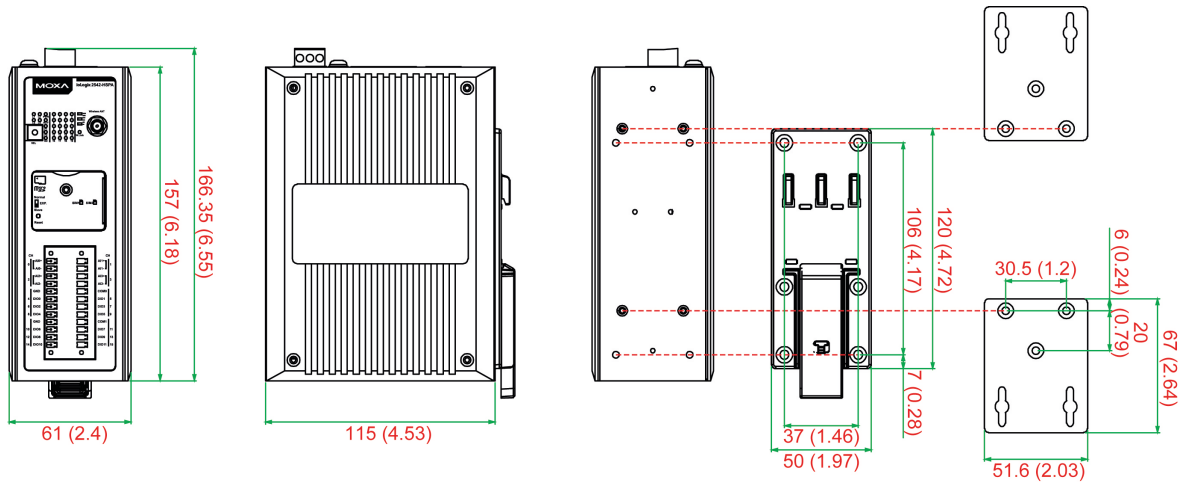

## Package Checklist

The ioLogik 2500 is shipped with the following items:

- ioLogik 2500 device
- 2 RJ45-to-DB9 connection cables (CBL-RJ45M9-150)
- 1 antenna (only for wireless models)
- Quick installation guide (printed)

**NOTE:** Please notify your sales representative if any of the above items are missing or damaged.

## Product Features

- Supports cellular (HSPA/GPRS), Ethernet, and serial communication (ioLogik 2500-HSPA/GPRS only)
- New Click&Go Plus logic provides powerful front-end intelligence
- Supports wireless LAN communication (ioLogik 2500-WL1 only)
- 4-port unmanaged switch built in for linking to Ethernet devices
- Optimized I/O expansion port for daisy chaining up to 8 ioLogik E1200 units
- 2 serial ports (RS-232/422/485) for connecting field devices
- Built-in data logger supports an FTP server/client and microSD™ card with up to a 32 GB
- Transforms Modbus RTU into Modbus TCP or Active Tags
- Active communication with patented MX-AOPC UA Server
- Smart alarm management: Email, SNMP traps, TCP, UDP, SMS
- Wide operating temperature: -40 to 75°C (-40 to 167°F)

## I/O Channels Available on ioLogik 2500 Models

Model Name	Digital Inputs	DI/DO (DIO) Configurable	Analog Inputs
ioLogik 2512	8	8	–
ioLogik 2542	–	12	4

## Communication Interface

Model Name	Communication Interface
ioLogik 2512 ioLogik 2542	Serial / Ethernet
ioLogik 2512-GPRS ioLogik 2542-GPRS	Serial / Ethernet / GPRS (2G)
ioLogik 2512-HSPA ioLogik 2542-HSPA	Serial / Ethernet / GPRS (2G) /HSPA (3G)
ioLogik 2512-WL1 ioLogik 2542-WL1	Serial / Ethernet / Wireless LAN

## ioLogik 2500 Ethernet Series Specifications

### Common Specifications

#### LAN

##### Ethernet:

- 4 switched 10/100 Mbps RJ45 ports
- 1 optimized port for faster downstream communications with daisy-chained ioLogik E1200 units

**Note:** The optimized daisy-chain port is not supported by the ioLogik E1261W-T, E1261H-T, or E1263H-T.

**Protection:** 1.5 kV magnetic isolation

**Protocols:** Modbus/TCP (slave), TCP/IP, UDP, DHCP, BOOTP, SNMP, HTTP, CGI, SNTP, SMTP

#### Serial

**Interface:** 2 RS-232/422/485 (software selectable) RJ45 ports

**Parity:** None, Odd, Even

**Data Bits:** 5, 6, 7, 8

**Stop Bits:** 1, 2

**Flow Control:** None, RTS/CTS, XON/XOFF

**Baudrate:** 300 to 115200 bps

**Protocols:** Modbus/RTU (master/gateway), serial tunnel mode (client/server)

#### Physical Characteristics

**Wiring:** I/O cable max. 14 AWG

**Dimensions:** 61 x 157 x 115 mm (2.4 x 6.18 x 4.53 in)

**Weight:** Under 1265 g (2.79 lb)

**Mounting:** DIN-rail (standard), wall (with optional kit)

#### Storage

**Expansion Slot:** Up to 32 GB microSD™ memory card (SDHC compatible)

**Note:** For units operating in extreme temperatures, industrial-grade, wide-temperature SD cards are required.

#### Environmental Limits

##### Operating Temperature:

Standard Models: -10 to 60°C (14 to 140°F)

Wide Temp. Models: -40 to 75°C (-40 to 167°F)

**Storage Temperature:** -40 to 85°C (-40 to 185°F)

**Ambient Relative Humidity:** 5 to 95% (non-condensing)

**Shock:** IEC 60068-2-27

**Vibration:** IEC 60068-2-6

**Altitude:** Up to 2000 m

**Note:** Please contact Moxa if you require products guaranteed to function properly at higher altitudes.



### Standards and Certifications

**Safety:** UL 508

**EMC:** EN 55032/24, EN 61000-6-2/6-4

**EMI:** CISPR 32, FCC Part 15B Class A

**EMS:**

IEC 61000-4-2 ESD: Contact: 4 kV; Air: 8 kV

IEC 61000-4-3 RS: 80 MHz to 1 GHz: 10 V/m

IEC 61000-4-4 EFT: Power: 1 kV; Signal: 0.5 kV

IEC 61000-4-5 Surge: Power: 1 kV

IEC 61000-4-6 CS: 3 V

IEC 61000-4-8

**Hazardous Location:** Class 1 Division 2; ATEX Zone 2

**Green Product:** RoHS, CRoHS, WEEE

**Note:** Please check Moxa's website for the most up-to-date certification status.

### Warranty

**Warranty Period:** 5 years

**Details:** See [www.moxa.com/warranty](http://www.moxa.com/warranty)

## ioLogik 2512 Ethernet Specifications

### Inputs and Outputs

**Digital Inputs:** 8 channels

**Configurable DIOs (by software):** 8 channels

**Isolation:** 3k VDC or 2k Vrms

### Digital Input

**Sensor Type:** Wet Contact (NPN or PNP) and Dry Contact

**I/O Mode:** DI or Event Counter

**Dry Contact:**

- On: short to GND
- Off: open

**Wet Contact (DI to COM):**

- On: 10 to 30 VDC
- Off: 0 to 3 VDC

**Common Type:** 8 points per COM

**Counter Frequency:** 2.5 kHz

**Digital Filtering Time Interval:** Software configurable

### Digital Output

**Type:** Sink

**I/O Mode:** DO or Pulse Output

**Pulse Output Frequency:** 5 kHz

**Over-Voltage Protection:** 45 VDC

**Over-Current Protection:** 1.5 A per channel @ 25°C

**Over-Temperature Shutdown:** 175°C (min.)

**Current Rating:** 500 mA per channel @ 25°C

**DIO Output Leakage Current:** < 1 mA @ 30 VDC

### Power Requirements

**Input Voltage:** 9 to 48 VDC

**Input Current:** 274 mA @ 24 VDC

### MTBF (mean time between failures)

**Time:** 467,032 hrs

**Standard:** Telcordia SR332

## ioLogik 2542 Ethernet Specifications

### Inputs and Outputs

**Configurable DIOs (by software):** 12 channels

**Analog Inputs:** 4 channels

**Isolation:** 3k VDC or 2k Vrms

### Digital Input

**Sensor Type:** Wet Contact (NPN or PNP) and Dry Contact

**I/O Mode:** DI or Event Counter

**Dry Contact:**

- On: short to GND
- Off: open

**Wet Contact (DI to COM):**

- On: 10 to 30 VDC
- Off: 0 to 3 VDC

**Common Type:** 6 points per COM

**Counter Frequency:** 2.5 kHz

**Digital Filtering Time Interval:** Software configurable

### Digital Output

**Type:** Sink

**I/O Mode:** DO or Pulse Output

**Pulse Output Frequency:** 5 kHz

**Over-Voltage Protection:** 45 VDC

**Over-Current Protection:** 1.5 A per channel @ 25°C

**Over-Temperature Shutdown:** 175°C (min.)

**Current Rating:** 500 mA per channel @ 25°C

**DIO Output Leakage Current:** < 1 mA @ 30 VDC

### Analog Input

**Type:** Differential input

**Resolution:** 16 bits

**I/O Mode:** Voltage / Current (software selectable)

**Input Range:** ±10 V, 0 to 10 V, 0 to 20 mA, 4 to 20 mA, 4 to 20 mA (burnout detection)

**Accuracy:**

- ±0.1% FSR @ 25°C
- ±0.3% FSR @ -10 and 60°C
- ±0.5% FSR @ -30 and 70°C

**Sampling Rate:**

- All channels: 400 samples/sec
- Per channel: 100 samples/sec

**Input Impedance:** 1 mega-ohm (min.)

**Built-in Resistor for Current Input:** 120 ohms

### Power Requirements

**Input Voltage:** 9 to 48 VDC

**Input Current:** 358 mA @ 24 VDC

### MTBF (mean time between failures)

**Time:** 375,439 hrs

**Standard:** Telcordia SR332

# ioLogik 2500 HSPA/GPRS/WLAN Series Specifications

## Common Specifications

### Cellular

**Standards:** GSM/GPRS/EDGE/UMTS/HSPA+

**HSPA Model Band Options:**

- UMTS/HSPA+: five-band 800/850/900/1900/2100 MHz
- GSM/GPRS/EDGE: quad-band 850/900/1800/1900 MHz

**GPRS Model Band Options:** GSM/GPRS/EDGE: quad-band 850/900/1800/1900 MHz

**SIM Control Voltage:** 3/1.8 V

**SIM Format:** Full size

### WLAN

**Standards:**

- IEEE 802.11a/b/g for wireless LAN
- IEEE 802.11i for wireless security

**Spread Spectrum and Modulation (typical):**

- DSSS with DBPSK, DQPSK, CCK
- OFDM with BPSK, QPSK, 16QAM, 64QAM
- 802.11b: CCK @ 11/5.5 Mbps, DQPSK @ 2 Mbps, DBPSK @ 11 Mbps
- 802.11a/g: 64QAM @ 54/48 Mbps, 16QAM @ 36/24 Mbps, QPSK @ 18/12 Mbps, BPSK @ 9/6 Mbps

**Operating Channels (central frequency):**

- US: 2.412 to 2.462 GHz (11 channels), 5.18 to 5.24 GHz (4 channels)
- EU: 2.412 to 2.472 GHz (13 channels), 5.18 to 5.24 GHz (4 channels)

**Security:**

- 64-bit and 128-bit WEP encryption
- Full WPA/WPA2 Personal

**Transmission Rates:**

- 802.11b: 1, 2, 5.5, 11 Mbps
- 802.11a/g: 6, 9, 12, 18, 24, 36, 48, 54 Mbps

**TX Transmit Power:**

- 802.11b: Typ. 18±1.5 dBm @ 1 to 11 Mbps
- 802.11g: Typ. 18±1.5 dBm @ 6 to 24 Mbps, Typ. 17±1.5 dBm @ 36 Mbps, Typ. 16±1.5 dBm @ 48 Mbps, Typ. 16±1.5 dBm @ 54 Mbps
- 802.11a: Typ. 18±1.5 dBm @ 6 to 24 Mbps, Typ. 16±1.5 dBm @ 36 Mbps, Typ. 15±1.5 dBm @ 48 Mbps, Typ. 14±1.5 dBm @ 54 Mbps

**RX Sensitivity:**

- 802.11b: -97 dBm @ 1 Mbps, -94 dBm @ 2 Mbps, -92 dBm @ 5.5 Mbps, -90 dBm @ 11 Mbps
- 802.11g: -88 dBm @ 6 to 24 Mbps, -85 dBm @ 36 Mbps, -75 dBm @ 48 Mbps, -70 dBm @ 54 Mbps
- 802.11a: -88 dBm @ 6 to 24 Mbps, -85 dBm @ 36 Mbps, -75 dBm @ 48 Mbps, -70 dBm @ 54 Mbps

### LAN

**Ethernet:**

- 4 switched 10/100 Mbps RJ45 ports
- 1 optimized port for faster downstream communications with daisy-chained ioLogik E1200 units

**Note:** The optimized daisy-chain port is not supported by the ioLogik E1261W-T, E1261H-T, or E1263H-T.

**Protection:** 1.5 kV magnetic isolation

**Protocols:** Modbus/TCP (slave), TCP/IP, UDP, DHCP, BOOTP, SNMP, HTTP, CGI, SNT, SMTP

### Serial

**Interface:** 2 RS-232/422/485 (software selectable) RJ45 ports

**Parity:** None, Odd, Even

**Data Bits:** 5, 6, 7, 8

**Stop Bits:** 1, 2

**Flow Control:** None, RTS/CTS, XON/XOFF

**Baudrate:** 300 to 115200 bps

**Protocols:** Modbus/RTU (master/gateway), serial tunnel mode (client/server)

### Physical Characteristics

**Wiring:** I/O cable, 14 AWG (max.)

**Dimensions:** 61 x 157 x 115 mm (2.4 x 6.18 x 4.53 in)

**Weight:** Under 1265 g (2.79 lb)

**Mounting:** DIN rail (standard), wall (optional)

### Storage

**Expansion Slot:** Up to 32 GB microSD™ memory card (SDHC compatible)

**Note:** For units operating in extreme temperatures, industrial-grade, wide-temperature SD cards are required.

### Environmental Limits

**Operating Temperature:**

Standard Models: -10 to 60°C (14 to 140°F)

Wide Temp. Models: -30 to 70°C (-22 to 158°F)

**Storage Temperature:** -40 to 85°C (-40 to 185°F)

**Ambient Relative Humidity:** 5 to 95% (non-condensing)

**Shock:** IEC 60068-2-27

**Vibration:** IEC 60068-2-6

**Altitude:** Up to 2000 m

**Note:** Please contact Moxa if you require products guaranteed to function properly at higher altitudes.

### Standards and Certifications

**Safety:** UL 508

**EMC:** EN 55032/24, EN 61000-6-2/6-4

**EMI:** CISPR 32, FCC Part 15B Class A

**EMS:**

IEC 61000-4-2 ESD: Contact: 4 kV; Air: 8 kV

IEC 61000-4-3 RS: 80 MHz to 1 GHz: 3 V/m

IEC 61000-4-4 EFT: Power: 1 kV; Signal: 0.5 kV

IEC 61000-4-5 Surge: Power 2 kV

IEC 61000-4-6 CS: 3 V

IEC 61000-4-8

**Radio:** R&TTE: EN 62311, EN 300 328, EN 301 489-1, EN 301 489-17, EN 301 893; NCC; VCCI

**Hazardous Location:** Class 1 Division 2; ATEX Zone 2

**Green Product:** RoHS, CRoHS, WEEE

**Note:** Please check Moxa's website for the most up-to-date certification status.

### Warranty

**Warranty Period:** 5 years

**Details:** See [www.moxa.com/warranty](http://www.moxa.com/warranty)

## ioLogik 2512 HSPA/GPRS/WLAN Specifications

### Inputs and Outputs

**Digital Inputs:** 8 channels

**Configurable DIOs (by software):** 8 channels

**Isolation:** 3k VDC or 2k Vrms

### Digital Input

**Sensor Type:** Wet Contact (NPN or PNP) and Dry Contact

**I/O Mode:** DI or Event Counter

**Dry Contact:**

- On: short to GND
- Off: open

**Wet Contact (DI to COM):**

- On: 10 to 30 VDC
- Off: 0 to 3 VDC

**Common Type:** 8 points per COM

**Counter Frequency:** 2.5 kHz

**Digital Filtering Time Interval:** Software configurable

**Digital Output**

**Type:** Sink

**I/O Mode:** DO or Pulse Output

**Pulse Output Frequency:** 5 kHz

**Over-Voltage Protection:** 45 VDC

**Over-Current Protection:** 1.5 A per channel @ 25°C

**Over-Temperature Shutdown:** 175°C (min.)

**Current Rating:** 500 mA per channel @ 25°C

**DIO Output Leakage Current:** < 1 mA @ 30 VDC

**Power Requirements**

**Input Voltage:** 9 to 48 VDC

**Input Current:**

- HSPA Model: 390 mA @ 24 VDC
- GPRS Model: 416 mA @ 24 VDC
- WL1 Model: 328 mA @ 24 VDC

**MTBF (mean time between failures)**

**Time:**

- HSPA model: 378,154 hrs
- GPRS model: 403,452 hrs
- WL1 model: 400,469 hrs

**Standard:** Telcordia SR332

## ioLogik 2542 HSPA/GPRS/WLAN Specifications

**Inputs and Outputs**

**Configurable DIOs (by software):** 12 channels

**Analog Inputs:** 4 channels

**Isolation:** 3k VDC or 2k Vrms

**Digital Input**

**Sensor Type:** Wet Contact (NPN or PNP) and Dry Contact

**I/O Mode:** DI or Event Counter

**Dry Contact:**

- On: short to GND
- Off: open

**Wet Contact (DI to COM):**

- On: 10 to 30 VDC
- Off: 0 to 3 VDC

**Common Type:** 6 points per COM

**Counter Frequency:** 2.5 kHz

**Digital Filtering Time Interval:** Software configurable

**Digital Output**

**Type:** Sink

**I/O Mode:** DO or Pulse Output

**Pulse Output Frequency:** 5 kHz

**Over-Voltage Protection:** 45 VDC

**Over-Current Protection:** 1.5 A per channel @ 25°C

**Over-Temperature Shutdown:** 175°C (min.)

**Current Rating:** 500 mA per channel @ 25°C

**DIO Output Leakage Current:** < 1 mA @ 30 VDC

### Analog Input

**Type:** Differential input

**Resolution:** 16 bits

**I/O Mode:** Voltage / Current (software selectable)

**Input Range:** ±10 V, 0 to 10 V, 0 to 20 mA, 4 to 20 mA, 4 to 20 mA (burnout detection)

**Accuracy:**

- ±0.1% FSR @ 25°C
- ±0.3% FSR @ -10 and 60°C
- ±0.5% FSR @ -30 and 70°C

**Sampling Rate:**

- All channels: 400 samples/sec
- Per channel: 100 samples/sec

**Input Impedance:** 1M ohms (min.)

**Built-in Resistor for Current Input:** 120 ohms

### Power Requirements

**Input Voltage:** 9 to 48 VDC

**Input Current:**

- HSPA Model: 442 mA @ 24 VDC
- GPRS Model: 494 mA @ 24 VDC
- WL1 Model: 406 mA @ 24 VDC

### MTBF (mean time between failures)

**Time:**

- HSPA model: 378,154 hrs
- GPRS model: 403,087 hrs
- WL1 model: 331,222 hrs

**Standard:** Telcordia SR332

# Installation

---

In this chapter, we provide instructions on how to install the ioLogik 2500 I/O server to connect to the network and serial devices.

The following topics are covered in this chapter:

❑ **Hardware Installation**

- Installing the ioLogik 2500 on a DIN Rail
- Removing the ioLogik 2500 from a DIN Rail

❑ **Powering on the ioLogik 2500**

❑ **Grounding the Unit**

❑ **Installing a microSD Card and SIM Cards (cellular models only)**

❑ **I/O Wiring Diagrams**

❑ **LED Indicators**

❑ **Daisy-Chaining for I/O Expansion**

❑ **Reset to Factory Defaults**

❑ **Network Installation**

- Ethernet Communication
- TCP/IP Settings
- Serial Communication

❑ **Software Installation—IExpress Utility**

- System Requirements
- Installing IExpress

# Hardware Installation

## Installing the ioLogik 2500 on a DIN Rail

The DIN-rail attachment plate should already be fixed to the back panel of your ioLogik 2500. If you need to reattach the plate, be sure the spring-loaded bracket is oriented towards the bottom, as shown in the figures below.

STEP 1: If the spring-loaded bracket is locked in place, push the recessed button to release it. Once released, you should feel some resistance from the spring as you slide the bracket up and down a few millimeters in each direction.

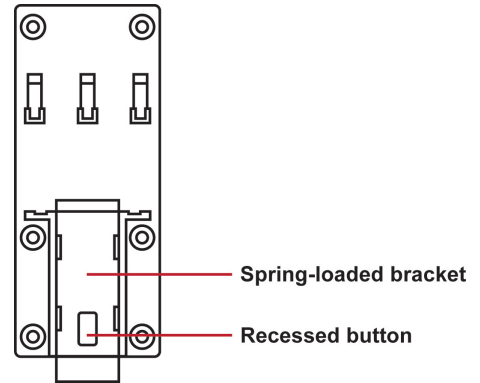

STEP 2: Insert the top of the rail into the upper lip of the attachment plate's slot.

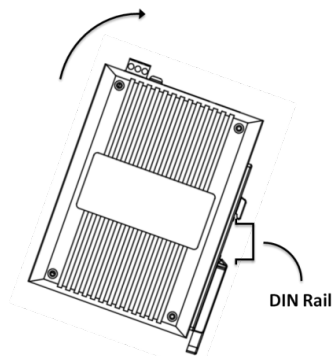

STEP 3: The attachment unit should now snap into place along the rail, as shown below.

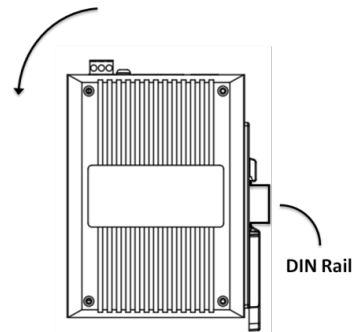

## Removing the ioLogik 2500 from a DIN Rail

To remove the ioLogik 2500 from a DIN rail, use a screwdriver to pull down the spring-loaded bracket until it locks in place, as shown in the diagram at the right. Next, rotate the bottom of the ioLogik 2500 upwards until you can remove it from the DIN rail.

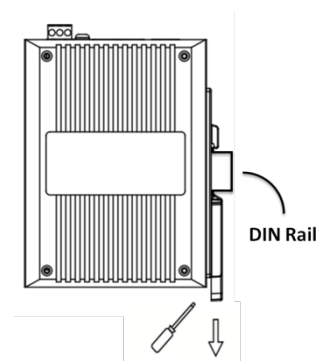

### WARNING

This equipment is intended to be used in Restricted Access Locations. External metal parts will be hot! Maintenance personnel should wear protective gear before touching the outside surface.







# Powering on the ioLogik 2500

The ioLogik 2500 can receive power from a 9 to 48 VDC power source. Input power is applied to the positive (V+) and negative (V-) terminals on the connector.

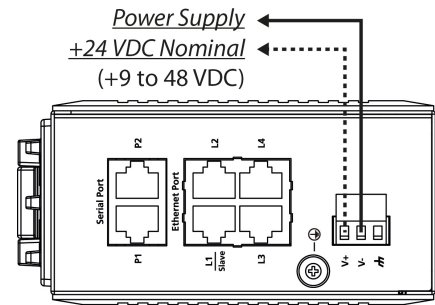
After connecting the ioLogik 2500 to the power supply, it will take 30 to 60 seconds for the operating system to boot up. The green Ready LED will illuminate continuously until the operating system is ready.



# Grounding the Unit

The ioLogik 2500 is equipped with a ground connector labeled .



### ATTENTION

Be sure to note the maximum possible current for each power wire and common wire. Observe all electrical codes dictating the maximum current allowable for each wire size. If currents exceed the maximum rating the wires will overheat, and may cause serious damage to the equipment. For safety reasons, wires connecting the power supply should be at least 2 mm in diameter (e.g., 12 gauge).

# Installing a microSD Card and SIM Cards (cellular models only)

The ioLogik 2500 supports a single microSD card and two SIM cards (cellular models only). The card slots are located inside the ioLogik 2500, as shown here. The card slot is hidden beneath a cover plate attached by a screw that must first be removed before the slot can be accessed. After removing the screw holding the cover plate in place you can insert or remove the microSD/SIM cards. Be sure to refasten the cover plate when you are done.

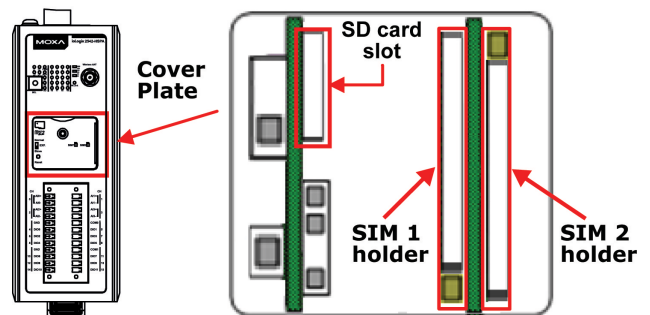

# I/O Wiring Diagrams

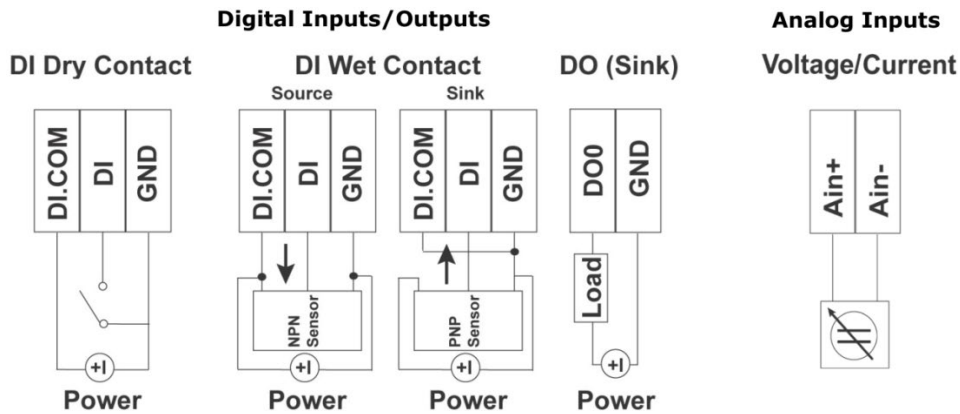

## LED Indicators

Type	Color	Description
Power (PWR)	Green	System power is ON
	Off	System power is OFF
Ready (RDY)	Green	System is ready
	Red	System error
	Green (blinking once per sec.)	Locating device
	Red (blinking once per sec.)	Expansion Runtime Error
	Green/Red (blinking once per 0.5 sec.)	Safe Mode
	Off	System is not ready
Ethernet Port (L1/L2/L3/L4)	Green	Ethernet connection enabled at 100 Mbps
	Amber	Ethernet connection enabled at 10 Mbps
	Blinking	Data is being transmitted
	Off	Disconnected
Serial Port (P1/P2)	Green	Tx
	Amber	Rx
	Blinking	Data is being transmitted
	Off	Disconnected
SD (Micro SD)	Green	SD card inserted
	Off	SD card is being accessed
I/O Channel Status* (0 to 15)	Green	Channel ON or Counter/Pulse signal
	Off	Channel OFF or No Counter/Pulse signal
W.Link**	Green	Wireless connection established
	Off	Off
Signal Status**	Off	No signal, or No SIM card
	1 LED	Weak or insufficient (SMS only)
	2 LEDs	Average (good for cellular connections)
	3 LEDs	Excellent signal

\*Use the rotary switch to select which module's I/O channel status is displayed.

- 0 = ioLogik 2500
- 1 to 8 = E1200 expansion
- 9 to F = Reserved

\*\*Wireless models only

# Daisy-Chaining for I/O Expansion

Up to 8 ioLogik E1200 devices can be connected in a daisy chain configuration to the ioLogik 2500 via the L1/Slave port on the ioLogik 2500. An IOxpress configuration scheme is called a project. If the IOxpress project includes expansion devices, the ioLogik 2500 will automatically start running in expansion mode.

If the ioLogik 2500 is running, you can replace one of the expansion units without powering down the ioLogik 2500. Take the following steps to replace an expansion unit:

1. Power-off the expansion unit.
2. Replace the unit with another expansion unit of the same model.
3. Access the DIP switch beneath the cover plate (as shown below).
4. Move the DIP switch from the down position to the up position to trigger the ioLogik 2500 to refresh its connection with the expansion units. If the DIP switch is already in the up position, move it down and then back up again.
5. The expansion unit will start running.

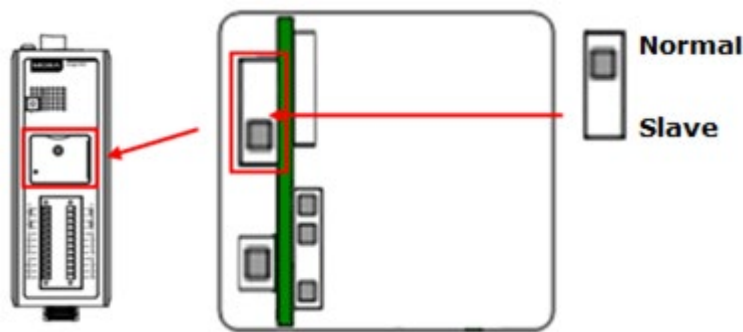

**NOTE** Expansion units must be replaced with the same model of expansion unit. If you would like to use a different expansion unit model, you must first change the relevant IOxpress settings.

The following figure illustrates a simple daisy-chain of I/O modules using the ioLogik 2500 for wireless connectivity.

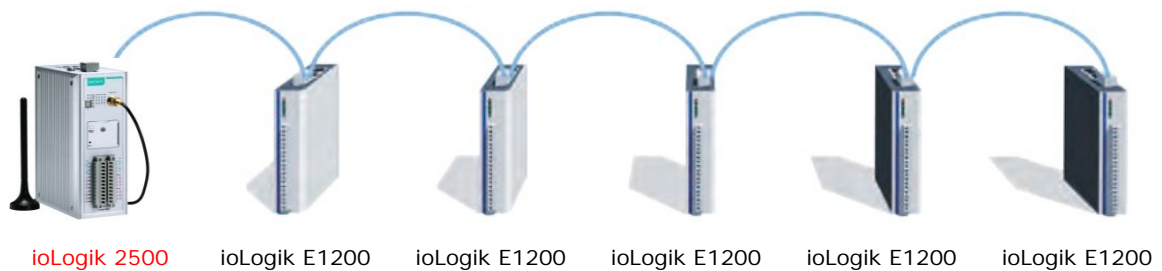

When daisy-chaining an array of devices, the first device in the chain (after the ioLogik 2500) must be connected to the L1 Slave port on the top of the ioLogik 2500 (outlined in red in the diagram).

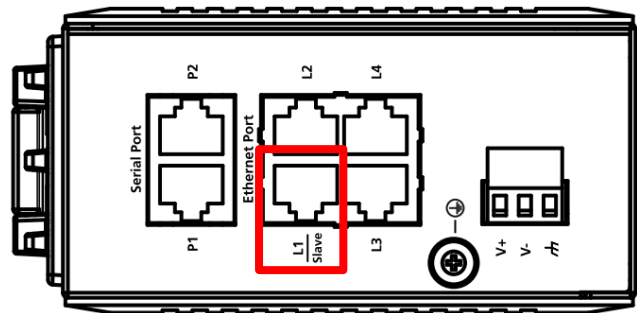



**ATTENTION**

When using the ioLogik 2500 as the head of an array of ioLogik E1200 modules, make sure that:

1. You connect the first E1200 expansion module in the array to the ioLogik 2500's L1 Slave port.
2. A maximum of 8 ioLogik E1200 devices are connected in a single array.
3. You only use ioLogik E1200 devices in the array. Other devices cannot be used as part of the array.

## Reset to Factory Defaults

If you need to reset the ioLogik 2500 to factory defaults, press and hold the reset button (located under the cover-plate, as shown in the diagram) for more than 5 seconds.

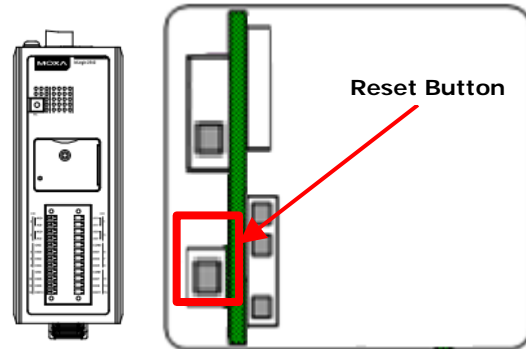

**WARNING**

Resetting your device to factory defaults will result in the loss of all configuration settings and any Click&Go Plus logic settings that have already been configured.

## Network Installation

### Ethernet Communication

Connections to the LAN port are made through an RJ45 connector on the ioLogik 2500 device. The wiring and pin connections for these connectors are described in separate sections below.



**ATTENTION**

The maximum cable length of a 10/100BaseT connection is 100 m (350 feet), but the actual limit could be shorter depending on the amount of electrical noise in the environment. To minimize the amount of noise, Ethernet cables should not run parallel to power cables or other cables that generate electrical noise.

### TCP/IP Settings

The following table shows the TCP/IP parameters supported by the LAN port. The ioLogik 2500 will revert to these default values whenever it is reset to factory defaults.

LAN Port	
Parameter	Supported Values
IP Address	Default: 192.168.127.253
Subnet Mask	Default: 255.255.255.0
Gateway	Default: 0.0.0.0

**IP Address**

The ioLogik 2500's IP address.

**Subnet Mask**

Determines which subnet the device is connected to.

**Gateway**

The gateway IP address, which determines how the controller communicates with devices outside its subnet.

The IP address, subnet mask, and gateway are static; contact your network administrator to obtain these addresses for the ioLogik 2500 device.

**Serial Communication**

The ioLogik 2500 is equipped with two 3-in-1 software-selectable RS-232/422/485 serial ports, making it more convenient to connect serial devices.

If required, the RJ45 to 8-pin male DB9 converter cables can be used to connect to serial devices.

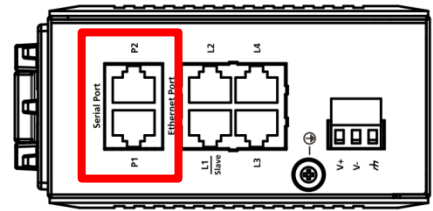

**NOTE** The ioLogik 2500 is shipped with 2 RJ45 to DB9 connection cables. If you need additional cables, contact your Moxa sales representative.

The model name of the connection cable is CBL-RJ45M9-150.

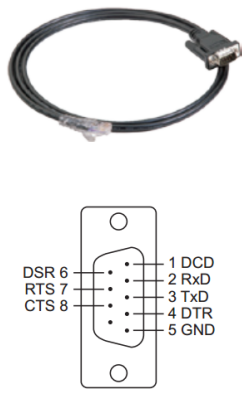

**DB9 Male Port Pinouts**

Pin	RS-232	RS-422	RS-485
1	DCD	RXD-	DATA-
2	RXD	RXD+	DATA+
3	TXD	TXD-	-
4	DTR	-	-
5	GND	GND	GND
6	DSR	-	-
7	RTS	TXD+	-
8	CTS	-	-

**Software Installation—IOxpress Utility**

The ioLogik 2500 can be remotely managed and configured over an Ethernet with Moxa's **IOxpress** utility. IOxpress is a Windows utility provided for the configuration and management of the ioLogik 2500. IOxpress can be used to remotely monitor and configure devices from any location on the network. The IOxpress graphical user interface provides easy access to all status information and configuration settings, and can also be used to configure Click&Go Plus rules and handle front-end events.

## System Requirements

Hardware Requirements	
CPU	Intel Pentium 4 CPU or higher
RAM	Min. 512 MB, 1024 MB is recommended
Network Interface	10/100 Ethernet
Software Requirements	
Operating System	Microsoft Windows 2000, XP or later

## Installing IOxpress

The software can be downloaded from Moxa's website. To do this, first click on the following link to access the website's search utility:

<http://www.moxa.com/support/search.aspx?type=soft>

When the web page opens, enter the model name of your product in the search box. Click the model name to navigate to the product page, and then click on **Utilities** (in the middle of the page), located in the box titled **Software**.

Download and unzip the file, and then run **SETUP.EXE** from that location.

The installation program will guide you through the installation process and install the software. After the installation is finished, run the software from the Windows Start menu.

**NOTE** Additional information on using IOxpress can be found in **Chapter 3: The IOxpress Utility**.

## The IOxpress Utility

---

In this chapter, we introduce Moxa's IOxpress Utility. The ioLogik 2500 can be managed and configured over an Ethernet using the IOxpress graphical user interface, which provides easy access to all status information and settings. IOxpress can also be used to configure Click&Go Plus rules to handle front-end events.

The following topics are covered in this chapter:

▣ **Application Interface**

- Main screen
- Menu Bar

▣ **Using IOxpress**

▣ **Configuration Flowchart**

- Offline Configuration Management
- Online Device Management

# Application Interface

## Main screen

The following figure shows the main screen of the IOxpress utility. There are four main areas:

- **Menu Bar**
- **Configuration Management**
- **Content Configuration**
- **Log Messages**

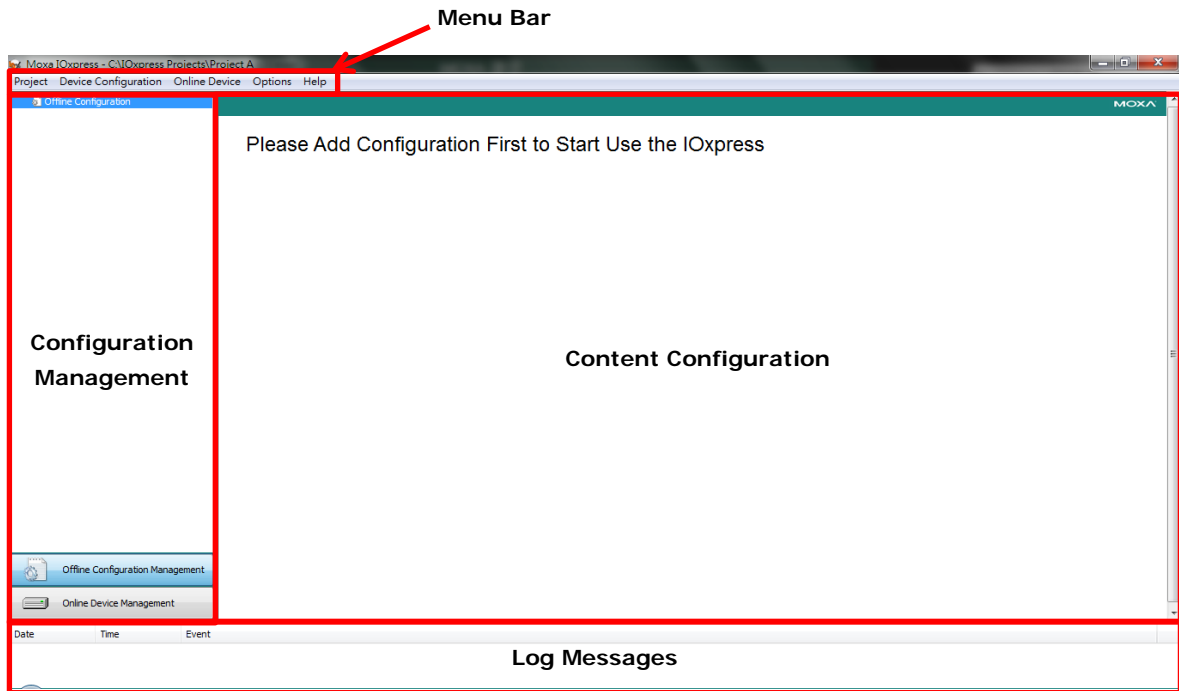

## Menu Bar

There are five tabs on the menu bar:

- **Project:** For managing projects.
- **Device Configuration:** Functions for offline configuration.
- **Online Device:** Functions for online configuration.
- **Options:** Preferences and network interface.
- **Help:** Version information

**NOTE** If the host computer has multiple interfaces, be sure to select the correct network interface before searching for online devices.



# Using IOxpress

IOxpress supports two configuration options: Offline Configuration Management and Online Device Management. Offline configuration is usually completed first, and then the configurations are uploaded over the network to online devices.

## Configuration Flowchart

The following flowchart gives an overview of the IOxpress configuration process. Once offline configuration is completed, you can start online configuration.

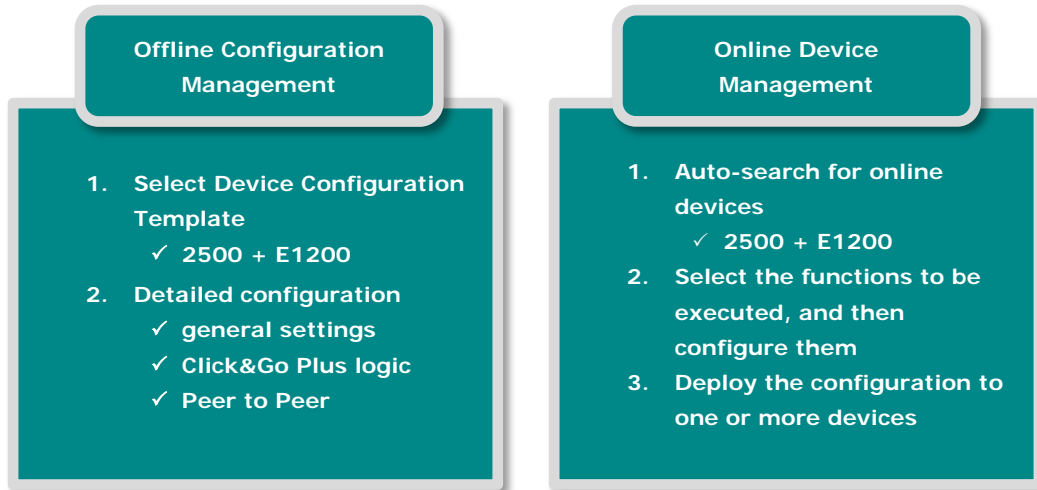

## Offline Configuration Management

The operator uses IOxpress to store configuration options offline in **IOxpress Projects**. The configuration settings are stored on the user's computer.

See Chapter 4 for a detailed explanation.

## Online Device Management

The operator uses IOxpress to export the configuration to devices on the network. That is, settings that were configured offline are exported over the network to online devices. This can be done either in batch mode, or on a case-by-case basis.

IOxpress can also be used to access online devices directly to check I/O status, upgrade firmware, export configurations, and restart devices.

See Chapter 5 for a detailed explanation.

# Offline Configuration Management

---

With Offline Configuration Management, the operator uses IOxpress to store configuration options offline in **IOxpress Projects**. The configuration settings are stored on the user's computer.

The following topics are covered in this chapter:

## ❑ Introduction

- Saving Configurations as a Project
- Adding an ioLogik 2500 Device to a Project
- Adding E1200 I/O Expansion Modules to a Project

## ❑ Setting Up a Device

### ❑ Settings Tab

- System
- Security
- Network
- I/O
- SNMP
- Modbus
- AOPC
- Serial Port (Port1/Port2)
- Data Logging
- Click&Go Plus

### ❑ Click&Go Plus Tab

### ❑ Click&Go Plus Simulator Tab

### ❑ Peer-to-Peer Tab

- General Settings
- Peer-to-Peer Rule Settings

# Introduction

With Offline Configuration Management, the operator uses IOxpress to store configuration options offline in **IOxpress Projects**. The configuration settings are stored on the user's computer.

## Saving Configurations as a Project

IOxpress configuration schemes are called **Projects** (saved as \*.prj files).

The first step to using IOxpress is to create a project for automating your device configuration processes. This can be done offline, after which the project can be exported to other devices over the network during the online configuration phase (discussed in Chapter 5).

Projects are automatically saved in the following folder:

```
C:\Users\Public\Documents\Moxa\IOxpress\Database
```

The first time you use offline configuration, create a new project by clicking **New** from the dropdown menu under the **Project** tab.

Click **Offline Configuration Management** and then select **Device Configuration** from the toolbar. You may click on either the **Add Configuration** or **Add Configuration from File...** option to add a configuration to the new project.

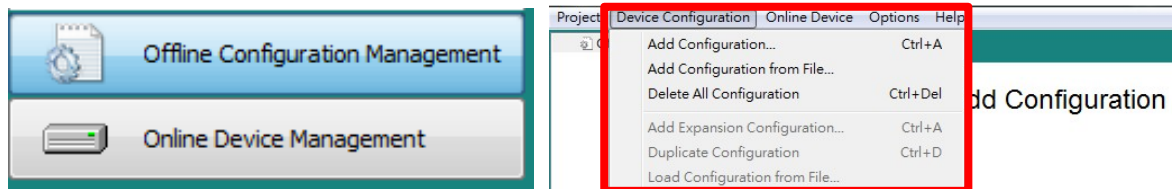

## Adding an ioLogik 2500 Device to a Project

The ioLogik 2500 can be used as the head of a cascaded array of ioLogik E1200 modules, with Click&Go Plus logic used to extend communication capability to the all of the expansion units.

## Adding E1200 I/O Expansion Modules to a Project

Up to 8 ioLogik E1200 series devices can be connected to the ioLogik 2500 in a daisy-chain configuration.

Right click on the ioLogik 2500 device you have just added, and then select **Add Expansion Configuration...**. After adding an E1200, the settings for the added device can be found in the **I/O settings, Tag selection, and data logging – profile** areas.

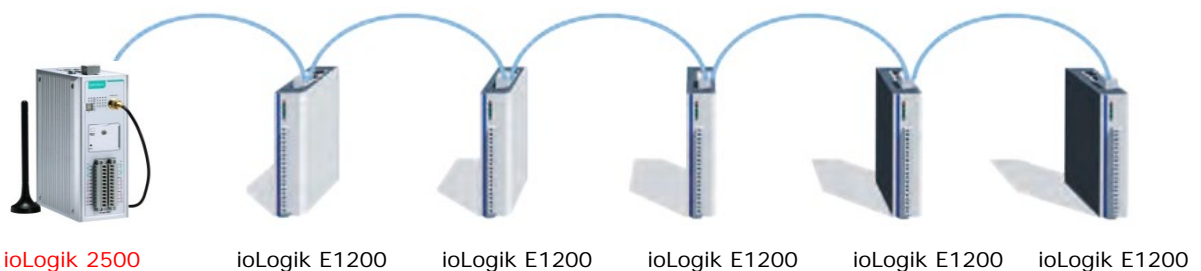
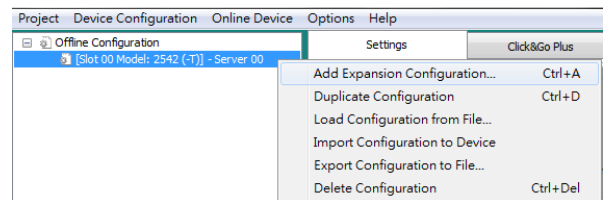



**ATTENTION**

If the IOExpress project includes expansion devices, the L1/slave port will automatically run in expansion mode.



**ATTENTION**

The IP address of the ioLogik 2500 should not be the same as its E1200 expansion units.

**NOTE** The following ioLogik E1200 models can be used for ioLogik 2500 I/O arrays:

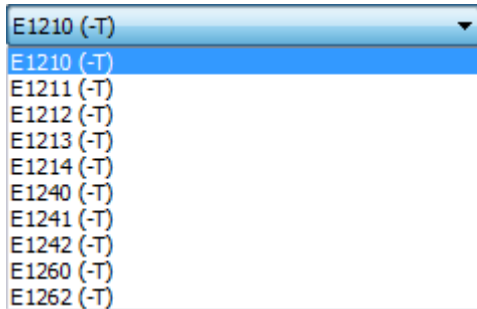

**NOTE** The location of each model is fixed. If you would like to change a device in an E1200 array, make sure that the order of the expansion modules is the same as in the Expansion Configuration list you just modified. An example is shown below:

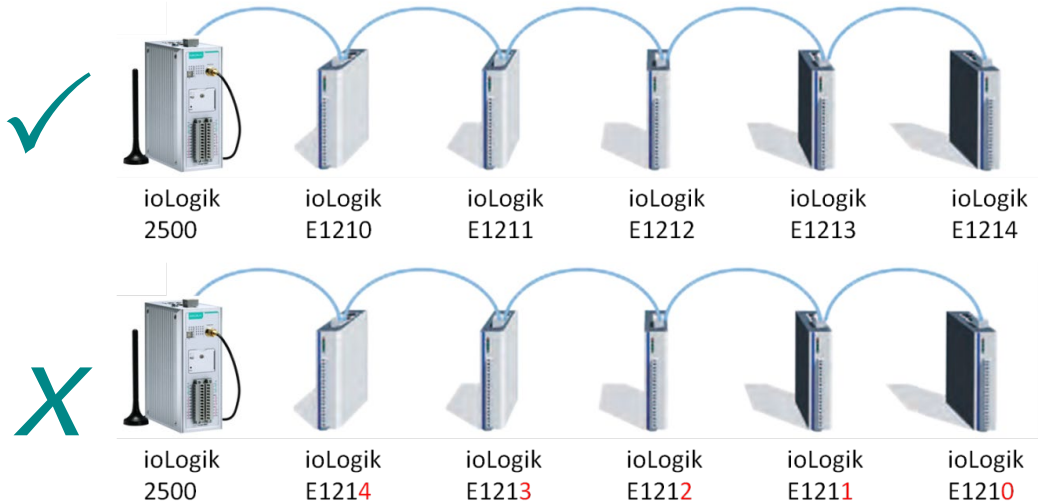
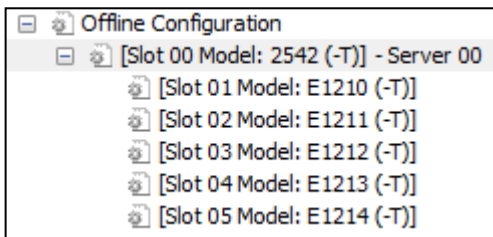

# Setting Up a Device

After you have created the project, you can start to configure each device in the project. The configuration window has four tabs:

- **Settings**
- **Click&Go Plus**
- **Click&Go Plus Simulator**
- **Peer-to-Peer**

## Settings Tab

The **Settings** panel includes basic settings used to set up devices.

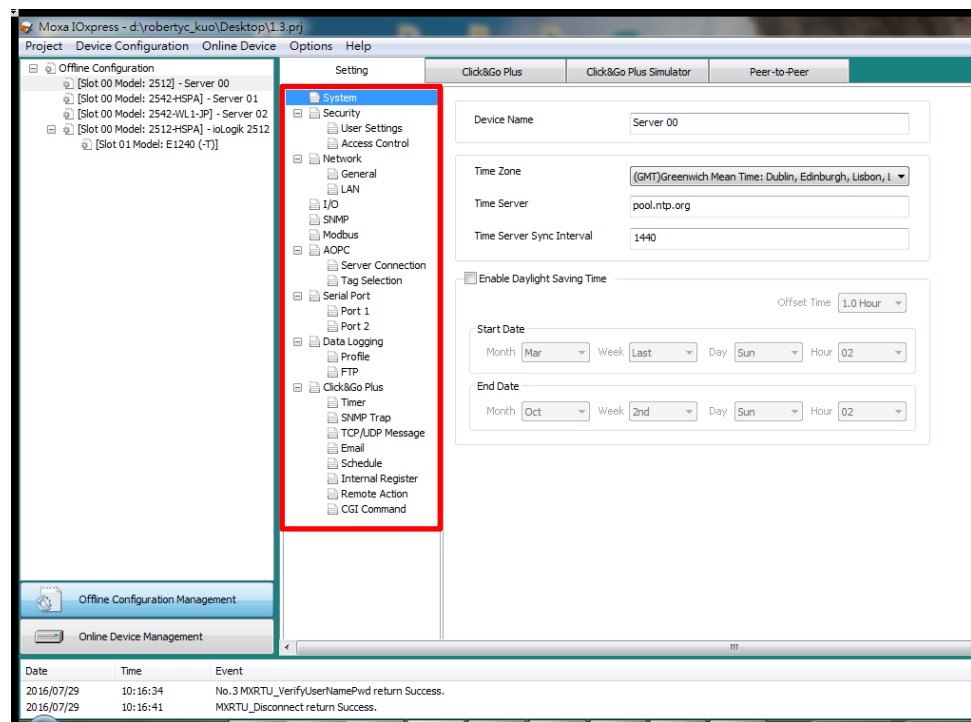

## System

Click **System** to configure the following items:

### Device Name

During offline configuration, the device name will appear in the list of ioLogik 2500 units.

During online configuration, the device name will appear in the mass deployment list.

IOxpress supports long device names up to 30 characters.

### Time Settings

The iologik 2500 will synchronize its time with the time server indicated in the Time Server box. During online configuration, you can sync the PC's time with the ioLogik 2500's time.

### Daylight Saving Time

Select the **Enable Daylight Saving Time** checkbox if your region supports daylight saving time, and then configure the Offset Time, Start Date, and End Date.

The detailed view of the System settings form for 'Server 01' shows the following fields:

- Device Name:** Server 01
- Time Zone:** (GMT)Greenwich Mean Time: Dublin, Edinburgh, Lisbon, I
- Time Server:** pool.ntp.org
- Time Server Sync Interval:** 1440
- Enable Daylight Saving Time:**  (checked)
- Offset Time:** 1.0 Hour
- Start Date:** Month: Mar, Week: Last, Day: Sun, Hour: 02
- End Date:** Month: Oct, Week: 2nd, Day: Sun, Hour: 02

## Security

Configure the security settings to increase the security level of the device. Be sure to change the default username/password the first time you configure this device, and then change it regularly thereafter.

### User Settings

Each ioLogik 2500 is limited to precisely three users. Only the **Username** and **Password** of each user can be modified. The **No.**, **Type**, and **Permission Level** items cannot be changed.

User Settings

No.	Type	Username	Permission Level
0	Administrator	admin	Full Control
1	Operator	operator	I/O Control
2	User	user	Read Only

Type:

Username:

New Password:

Confirm Password:

Note: If administrator's username or password is changed, enter old username and password when updating this new configuration to the device.

The factory defaults and access rights of the three user types are described below:

User Type	Factory Default	Access Right
Administrator	admin	Full control, including the ability to configure the device
Operator	operator	Can control I/O status through the web console
User	user	Can check I/O status through the web console

The characteristics of the username and password are described below:

**Username:**

- Length: 1 to 30 characters
- Acceptable characters: A to Z, a to z, 0 to 9, symbols; spaces are not allowed
- Factory defaults: (see table above)

**Password:**

- Length: 4 to 30 characters
- Acceptable characters: A to Z, a to z, 0 to 9, symbols
- Factory default: moxa

**NOTE** Since the configuration is being done offline, the results are stored in your computer, and not in the ioLogik device. Therefore, when updating this configuration to the ioLogik device, you will need to log in with the previous password.

 **ATTENTION** To guard against cyber attacks, be sure to change the default password of each username before you start using your ioLogik devices, and then change the passwords at regular intervals.

## Access Control

Use IP Address / Netmask combinations to control which devices can use the Modbus/TCP protocol to access your ioLogik device.

Only allow below IP address to access Modbus address

No.	IP Address	Netmask
<input checked="" type="checkbox"/> 0	192.168.127.50	255.255.255.0
<input type="checkbox"/> 1	0.0.0.0	255.255.255.0
<input type="checkbox"/> 2	0.0.0.0	255.255.255.0
<input type="checkbox"/> 3	0.0.0.0	255.255.255.0
<input type="checkbox"/> 4	0.0.0.0	255.255.255.0
<input type="checkbox"/> 5	0.0.0.0	255.255.255.0
<input type="checkbox"/> 6	0.0.0.0	255.255.255.0
<input type="checkbox"/> 7	0.0.0.0	255.255.255.0
<input type="checkbox"/> 8	0.0.0.0	255.255.255.0
<input type="checkbox"/> 9	0.0.0.0	255.255.255.0

## Network

There are three sub-pages under **Network**: **General**, **LAN**, **Cellular** (applies to the ioLogik 2500-GPRS/HSPA only), and **Wi-Fi** (applies to the ioLogik 2500-WL1 only).

### General

There are two columns under General: **Select Network Interface** and **General Settings**.

#### Select Network Interface

**Select Network Interface** is only available for the ioLogik 2500-GPRS/HSPA models. See **Chapter 4: Cellular Network Setup and Configuration** for details.

#### General Settings

General Settings

Enable Web Console

Enable Server Socket Idle Connection Timeout (sec(s))

Private IP for the First Expansion Module

#### Enable Web Console

Use this checkbox to enable or disable the web console. When enabled, the ioLogik can be configured from a web browser. If not enabled, you will not be able to open the web console.

#### Enable Server Socket Idle Connection Timeout

**Server Socket Idle Connection Timeout** is designed to avoid TCP connection failures when the network host is unable to respond due to a hardware failure or network problem.

If **Server Socket Idle Connection Timeout** is enabled: When the server’s connection to the ioLogik 2500 exceeds the specified time period the device will automatically release its TCP connection to the server to free up the port for the next connection.

If **Server Socket Idle Connection Timeout** is not enabled: If the network host is unable to respond due to a hardware failure or network problem, the ioLogik will continue to wait for a response from the host, causing the TCP port to be occupied indefinitely by the host.

**Private IP for the First Expansion Module**

An array of up to 8 modules can be connected to the ioLogik 2500. **Private IP for First Expansion Module** assigns an IP to the first E1200 module. The IPs for subsequent modules in the chain will be automatically assigned consecutively. For example, if the IP of the first E1200 device is set to 192.168.120.1, the IP of the second E1200 will be 192.168.120.2, the third IP will be 192.168.120.3, and so on.

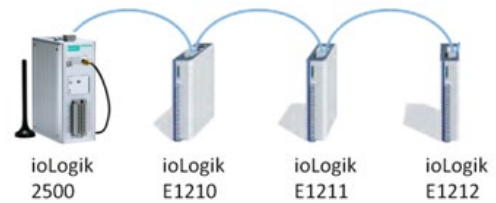
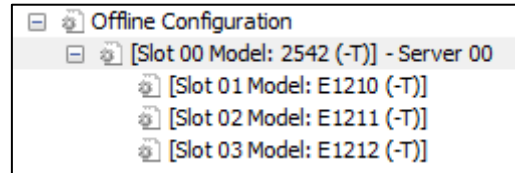

**LAN**

**IP Settings**

You can set up a static or dynamic IP address for the ioLogik, as well as the subnet mask and gateway address.

Use this field to specify the IP addresses of one or two DNS servers. DNS servers can be used to find available e-mail addresses when setting up Click&Go Plus rules.

**NOTE** The ioLogik 2500-WL1 only supports static IP addresses.

**Cellular (ioLogik 2500-GPRS/HSPA only)**

**Cellular** is only available for the ioLogik 2500-GPRS/HSPA models. See **Chapter 4: Cellular Network Setup and Configuration** for details.

**Wi-Fi (ioLogik 2500-WL1 Only)**

**Wi-Fi** is only available for the ioLogik 2500-WL1 models. See **Chapter 5: Wireless LAN Network Setup and Configuration** for details.



# I/O

In the I/O section, you can configure I/O settings for ioLogik 2500 devices. Items that can be modified will be shown in **black**. Items that cannot be modified will be shown in **light gray**. Because revising channel type and name also changes each I/O setting, we recommend configuring the I/O Mode Settings first.

Slot Number	Channel No	Channel Type	Channel Mode	Name
[Slot 00 Model: 2542 (-T)]	0	AI	0-10V	AI-00
[Slot 00 Model: 2542 (-T)]	1	AI	0-10V	AI-01
[Slot 00 Model: 2542 (-T)]	2	AI	0-10V	AI-02
[Slot 00 Model: 2542 (-T)]	3	AI	0-10V	AI-03
[Slot 00 Model: 2542 (-T)]	4	DIO	DI	DIO-00
[Slot 00 Model: 2542 (-T)]	5	DIO	DI	DIO-01
[Slot 00 Model: 2542 (-T)]	6	DIO	DI	DIO-02
[Slot 00 Model: 2542 (-T)]	7	DIO	DI	DIO-03
[Slot 00 Model: 2542 (-T)]	8	DIO	DI	DIO-04
[Slot 00 Model: 2542 (-T)]	9	DIO	DI	DIO-05
[Slot 00 Model: 2542 (-T)]	10	DIO	DI	DIO-06
[Slot 00 Model: 2542 (-T)]	11	DIO	DI	DIO-07
[Slot 00 Model: 2542 (-T)]	12	DIO	DI	DIO-08
[Slot 00 Model: 2542 (-T)]	13	DIO	DI	DIO-09
[Slot 00 Model: 2542 (-T)]	14	DIO	DI	DIO-10
[Slot 00 Model: 2542 (-T)]	15	DIO	DI	DIO-11
[Slot 00 Model: 2542 (-T)]	16	Virtual Channel	Disable	Virtual Channel-00
[Slot 00 Model: 2542 (-T)]	17	Virtual Channel	Disable	Virtual Channel-01
[Slot 00 Model: 2542 (-T)]	18	Virtual Channel	Disable	Virtual Channel-02
[Slot 00 Model: 2542 (-T)]	19	Virtual Channel	Disable	Virtual Channel-03
[Slot 00 Model: 2542 (-T)]	20	Virtual Channel	Disable	Virtual Channel-04
[Slot 00 Model: 2542 (-T)]	21	Virtual Channel	Disable	Virtual Channel-05
[Slot 00 Model: 2542 (-T)]	22	Virtual Channel	Disable	Virtual Channel-06
[Slot 00 Model: 2542 (-T)]	23	Virtual Channel	Disable	Virtual Channel-07
[Slot 00 Model: 2542 (-T)]	24	Virtual Channel	Disable	Virtual Channel-08
[Slot 00 Model: 2542 (-T)]	25	Virtual Channel	Disable	Virtual Channel-09

Setting	Functions
IO Mode Setting	Channel Mode Name
DI Setting	Filter
Counter Setting	Filter Initial Value Active Mode Power On Status Scaling Enable Scaling Offset Scaling Interval
DO Setting	Enable Communication Watchdog for Safe Mode Enable Auto Clear Safe Mode Power On Status Power On Delay Safe Mode Status
Pulse Setting	On Width Off Width Count Power On Status Power On Delay Safe Mode Status
AI Setting	Input Range Burnout Value Scaling Slope Scaling Offset Scaling Unit
Virtual Channel Setting	Enable Slot No. Channel No. Function Interval (min) Sampling Time (min)

### Select Module

Select the module that you would like to configure. You may select **All** modules, in which case information on all I/O channels in the project will be displayed.

Select Module All ▼

**IO Mode Setting**

• **Channel Mode**

DIO channels can be set to one of four modes: **DI**, **Event Counter**, **DO**, or **Pulse output**. AI channels can be set to one of five modes: **±10 V**, **0 to 10 V**, **0 to 20 mA**, **4 to 20 mA**, or **4 to 20 mA (Burnout)**. AO channels can be set to one of two modes: **0 to 10 V** and **4 to 20 mA**.

**NOTE** Since the ioLogik 2500 does not have AO channels, the AO setting will only show up when the project contains E1200 AO modules, such as the E1241.

• **Name**

The name will be attached to the AOPC tag to help users identify channel information in MX-AOPC.

**DI Setting**

**Filter:** Software filtering is used to avoid switch bounces. The filter is configurable in multiples of 100 µs and accepts values between 1 and 65535.

Detail Setting DI Setting

Enable Communication Watchdog for Safe Mode  sec  Enable Auto Clear Safe Mode

Slot Number	Channel No	Filter	Filter Unit
[Slot 00 Model: 2542 (-T)]	4	1	100 us
[Slot 00 Model: 2542 (-T)]	5	1	100 us
[Slot 00 Model: 2542 (-T)]	6	1	100 us
[Slot 00 Model: 2542 (-T)]	7	1	100 us
[Slot 00 Model: 2542 (-T)]	8	1	100 us
[Slot 00 Model: 2542 (-T)]	9	1	100 us
[Slot 00 Model: 2542 (-T)]	10	1	100 us
[Slot 00 Model: 2542 (-T)]	11	1	100 us
[Slot 00 Model: 2542 (-T)]	12	1	100 us
[Slot 00 Model: 2542 (-T)]	13	1	100 us
[Slot 00 Model: 2542 (-T)]	14	1	100 us
[Slot 00 Model: 2542 (-T)]	15	1	100 us

**Counter Setting**

**Counter** refers to an **Event Counter** channel. Counts are stored internally.

Detail Setting Counter Setting

Enable Communication Watchdog for Safe Mode  sec  Enable Auto Clear Safe Mode

Slot Number	Channel No	Filter	Filte...	Initial Value	Active Mode	Power On Status	Scaling Enable	Scaling Slope	Scaling Offset	Scaling Interval
[Slot 00 Model: 2542 (-T)]	4	1	100 us	0	Raising edge	Stop	Disable	1	0	5
[Slot 00 Model: 2542 (-T)]	5	1	100 us	0	Raising edge	Stop	Disable	1	0	5
[Slot 00 Model: 2542 (-T)]	6	1	100 us	0	Raising edge	Stop	Disable	1	0	5
[Slot 00 Model: 2542 (-T)]	7	1	100 us	0	Raising edge	Stop	Disable	1	0	5

• **Filter**

Software filtering is used to avoid switch bounces. The filter is configurable in multiples of 100 µs and accepts values between 1 and 65535.

• **Initial Value**

The initial value is the start value in counter mode.

• **Active Mode**

In **Active mode**, the channel accepts limit or proximity switches and counts events according to the ON/OFF status. When **Rising edge** is selected, the counter value increases when the attached switch is pushed. When **Falling edge** is selected, the counter value increases when the switch is released. When **Both** is selected, the counter value increases when the attached switch is pushed or released.

- **Power On Status**

To enable the counter to resume counting immediately upon powering up, enable the **Power On Status**.

**Stop:** The counter starts logging signals only after configured to do so by a Modbus or a Click&Go Plus command.

**Start:** Counting begins automatically whenever the ioLogik is powered on.

- **Scaling Enable / Scaling Slope / Scaling Offset / Scaling Interval (sec)**

Set the **Slope & Offset** to convert the Counter value to new units.

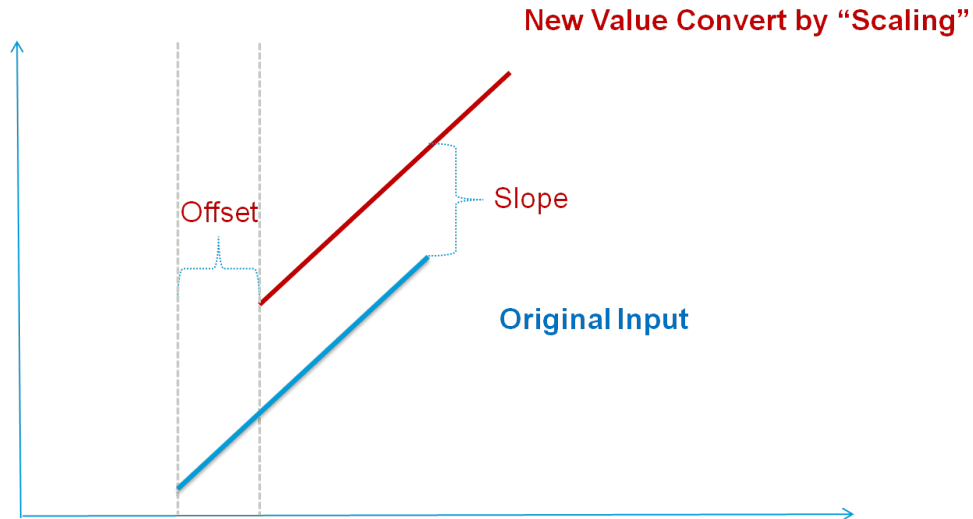

**DO Setting**

Detail Setting DO Setting

Enable Communication Watchdog for Safe Mode  sec  Enable Auto Clear Safe Mode

Slot Number	Channel No	Power On Status	Power On Delay (s)	Safe Mode Status
[Slot 00 Model: 2542 (-T)]	8	Off	0	Off
[Slot 00 Model: 2542 (-T)]	9	Off	0	Off
[Slot 00 Model: 2542 (-T)]	10	Off	0	Off
[Slot 00 Model: 2542 (-T)]	11	Off	0	Off

- **Enable Communication Watchdog for Safe Mode**

When the watchdog is enabled, any disconnection from the network will activate a safe state. In the safe mode, DO channels can be configured to turn on, turn off, or commence pulse output during the safe state. If the watchdog is not enabled, then DO channel status will remain unchanged during a network disconnection.

To configure a DO for safe mode, set the corresponding value in the **Safe Mode Status** column to ON.

- **Enable Auto Clear Safe Mode**

When detecting the reconnection of Ethernet signals, the device will auto clear the safe mode status.

- **Power On Status**

When the device is powered on, the status of each DO channel is set to **OFF** by default. This status can be modified to **ON**.

- **Power On Delay**

The time delay from tuning DO channels when the power is turned on.

- **Safe Mode Status**

**Enable Communication Watchdog for Safe Mode** allows you to control how DO and pulse output channels act when the network is disconnected.

If the Communication Watchdog is enabled, a network disconnection will activate a safe state. The DO channel can be configured to turn on / turn off during the safe state.

If the Communication Watchdog is not enabled, then the DO channel status will remain unchanged during a network disconnection.

**Pulse Setting**

Detail Setting Pulse Setting

Enable Communication Watchdog for Safe Mode  sec  Enable Auto Clear Safe Mode

Slot Number	Channel No	On Width	Off Width	Width Unit	Count	Power On Status	Power On Delay (s)	Safe Mode Status
[Slot 00 Model: 2542 (-T)]	12	1	1	100 us	0	Stop	0	Stop
[Slot 00 Model: 2542 (-T)]	13	1	1	100 us	0	Stop	0	Stop
[Slot 00 Model: 2542 (-T)]	14	1	1	100 us	0	Stop	0	Stop
[Slot 00 Model: 2542 (-T)]	15	1	1	100 us	0	Stop	0	Stop

- **On Width / Off Width**

In **Pulse Output mode**, the selected digital output channel will generate a square wave as specified in the pulse mode parameters. The low and high level widths are specified in multiples of 100 μs, with a maximum setting of 65,535.

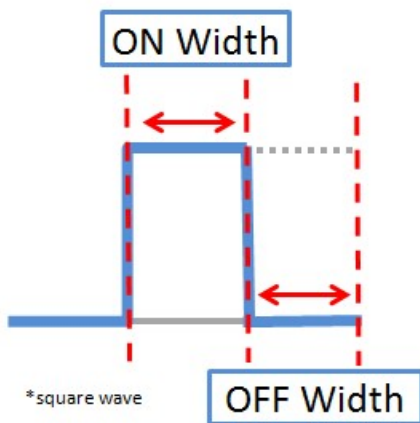

- **Count**

You can specify between 1 and 4,294,967,295 pulses or enter "0" for continuous pulse output.

- **Power On Status**

When the device is first powered on, the status of each pulse output channel is set to **OFF** by default.

You can set a pulse output channel to turn **ON** when the ioLogik is powered on, or to commence pulse output.

- **Power On Delay**

The time delay from turning Pulse channels when the power is turned on.

- **Safe Mode Status**

If the Communication Watchdog is enabled, a network disconnection will activate a safe state. The pulse output channel can be configured to turn on / turn off during the safe state.

**AI Setting**

Detail Setting AI Setting

Enable Communication Watchdog for Safe Mode 30 sec  Enable Auto Clear Safe Mode

Slot Number	Channel No	Channel Mode	Burnout Value	Scaling Slope	Scaling Offset	Scaling Unit
[Slot 00 Model: 2542 (-T)]	0	0-10V		1.000000	0.000000	V
[Slot 00 Model: 2542 (-T)]	1	0-10V		1.000000	0.000000	V
[Slot 00 Model: 2542 (-T)]	2	0-10V		1.000000	0.000000	V
[Slot 00 Model: 2542 (-T)]	3	0-10V		1.000000	0.000000	V

• **Channel Mode**

The input channels can be set individually to ±10 V, 0 to 10 V, 0 to 20 mA, 4 to 20 mA, and 4 to 20 mA (Burnout).

• **Burn-out Value**

Burn Out mode indicates when the Current AI has burned out. For example, the 4–20 mA Burn-out mode is defined in the following diagram:

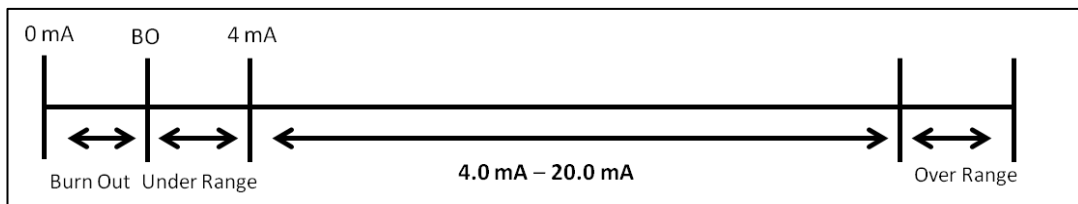

Users can define Burn-out (BO) values (default = 2 mA) for selected ranges. When input values are in the Burn Out range, raw data will register as 0000h to indicate that the analog input has burned out. The definition of raw data is as follows:

Burnout Value (BO)	0.0 < BO < 4.0	User defined (default 2 mA)
Burnout State	0 ≤ AI < BO mA	Modbus output 0000h
Under Range	BO ≤ AI < 4 mA	Modbus output raw data
Normal Range	4 ≤ AI ≤ 20.00 mA	Modbus output raw data until FFEh
Over Range	XX > 20.00 mA	Modbus output FFFFh

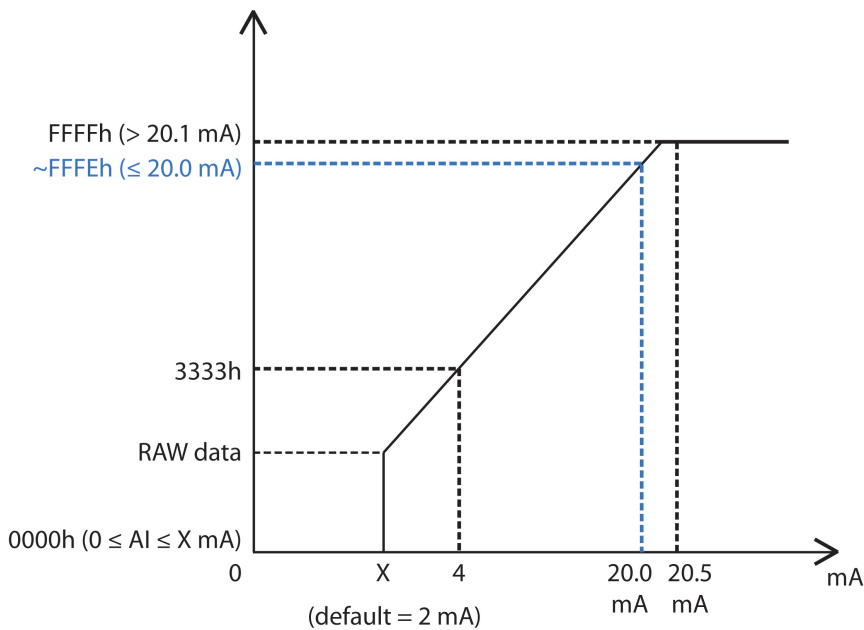

- **Scaling Slope / Scaling Offset /Scaling Unit**

Enabling the Scaling functions will linearly convert the actual current or voltage value into other user-defined units, such as percentage or ppm (parts per million).

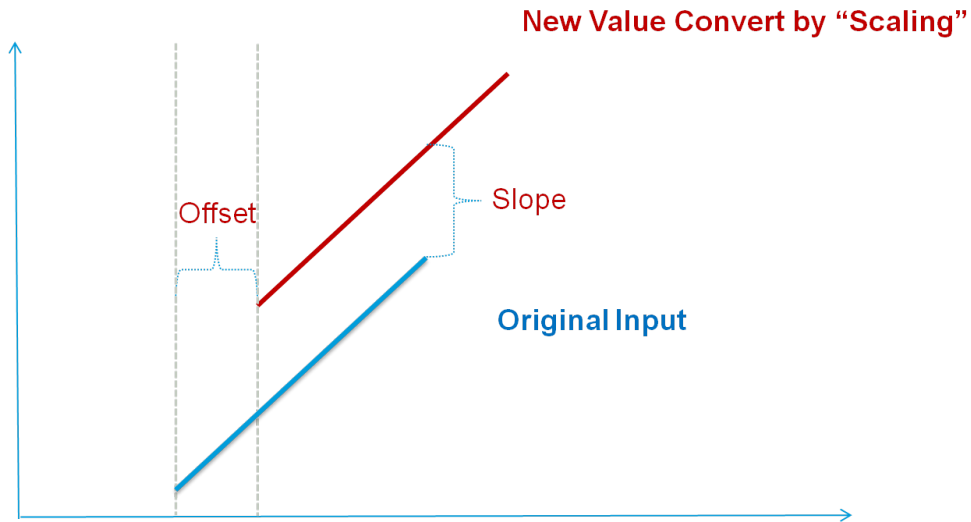

**AO Setting**

Detail Setting AO Setting

Enable Communication Watchdog for Safe Mode 30 sec  Enable Auto Clear Safe Mode

Slot Number	Channel No	Channel Mode	Scaling Slope	Scaling Offset	Scaling Unit	Power On Status	Safe Mode Status
[Slot 02 Model: E1241 (-T)]	0	4-20mA	1.000000	0.000000	mA	4.000000	4.000000
[Slot 02 Model: E1241 (-T)]	1	4-20mA	1.000000	0.000000	mA	4.000000	4.000000
[Slot 02 Model: E1241 (-T)]	2	4-20mA	1.000000	0.000000	mA	4.000000	4.000000
[Slot 02 Model: E1241 (-T)]	3	4-20mA	1.000000	0.000000	mA	4.000000	4.000000

- **Channel Mode**

There are two modes for the AO channels: Voltage Mode (V) and Current Mode (mA).

- **Scaling Slope / Scaling Offset / Scaling Unit**

Enabling the Scaling functions will linearly convert the actual current or voltage value into other user-defined units, such as percentage or ppm (parts per million).

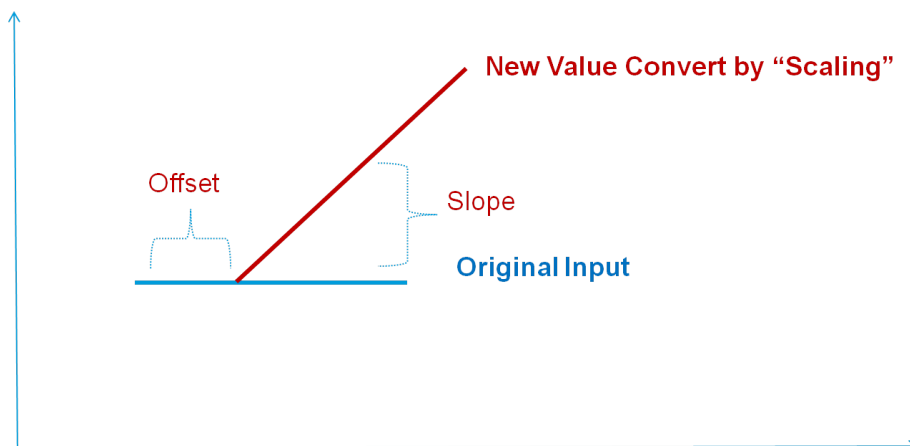

- **Power On Status**

When the device is first powered on, the status of each AO channel can be modified using the **Power On Status**.

• **Safe Mode Status**

**Enable Communication Watchdog for Safe Mode** allows you to control how an AO channel acts when the network is disconnected.

If the Communication Watchdog is enabled, a network disconnection will activate a safe state. The AO channel can be configured to a defined value during the safe state.

**NOTE** Since the ioLogik 2500 does not have AO channels, the AO setting will only show up when the project contains E1200 AO modules (such as the E1241).

**Virtual Channel Setting**

Detail Setting Virtual Channel Setting

Enable Communication Watchdog for Safe Mode  sec  Enable Auto Clear Safe Mode

Slot Number	Channel No	Enable	Slot No	Channel No	Function	Interval (min.)	Sampling Time (min.)
[Slot 00 Model: 2542 (-T)]	16	Disable	2542 (-T)	None	Maximum	1	
[Slot 00 Model: 2542 (-T)]	17	Disable	2542 (-T)	None	Maximum	1	
[Slot 00 Model: 2542 (-T)]	18	Disable	2542 (-T)	None	Maximum	1	
[Slot 00 Model: 2542 (-T)]	19	Disable	2542 (-T)	None	Maximum	1	
[Slot 00 Model: 2542 (-T)]	20	Disable	2542 (-T)	None	Maximum	1	
[Slot 00 Model: 2542 (-T)]	21	Disable	2542 (-T)	None	Maximum	1	
[Slot 00 Model: 2542 (-T)]	22	Disable	2542 (-T)	None	Maximum	1	
[Slot 00 Model: 2542 (-T)]	23	Disable	2542 (-T)	None	Maximum	1	
[Slot 00 Model: 2542 (-T)]	24	Disable	2542 (-T)	None	Maximum	1	
[Slot 00 Model: 2542 (-T)]	25	Disable	2542 (-T)	None	Maximum	1	

The ioLogik 2500 has 10 internal virtual channels to support front-end statistics functions.

The data source is the real I/O channel, such as AI and DI counters, some of which need to be converted to the appropriate time unit. The operation is illustrated below.

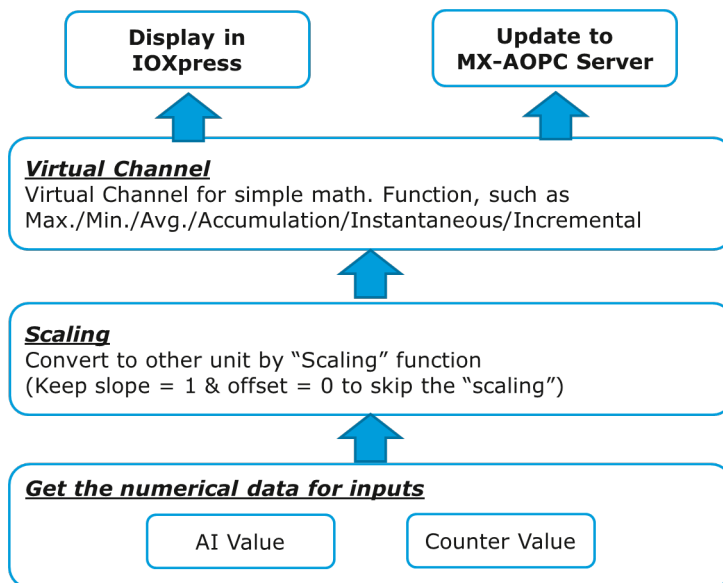

**NOTE** For AI/Counter scaling, configure Scaling on the AI or Counter Configuration panel before selecting operations in the virtual channels.

For example, if you want to monitor the daily flow at a point in a pipeline, you can use a pulse output flow meter, where 1 pulse indicates 5 ml. You can set the virtual channel's **scaling function** so that 1 tick of counter input equals 5 ml. Next, set the **Accumulation** flag, and configure the **Time Interval** to 24 hours. This will set up the virtual channel to log the total water flow volume over a period of 24 hours.



- **Status**

Enable/Disable virtual channels.

- **Slot No.**

If you have connected E1200 expansion modules, select the device you would like to configure here.

Slot No
2542 (-T)
2542 (-T)
[Slot 01 Model: E1210 (-T)]

- **Channel No.**

Virtual channels are required to configure AI or counter channels.

- **Function**

There are six functions: Max, Min, Average, Accumulation, Instantaneous, and Incremental.

**Maximum:**

The maximum value within Z sec, with sampling done every 10 ms.

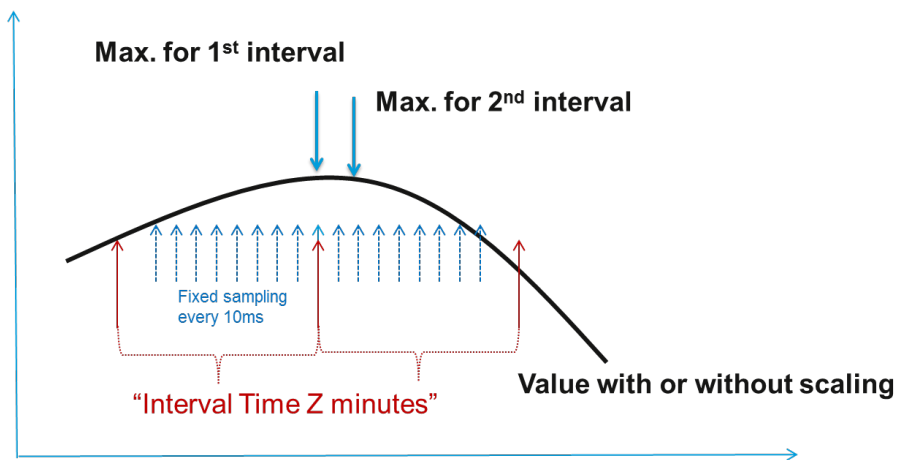

**Minimum:**

The minimum value within Z sec, with sampling done every 10 ms.

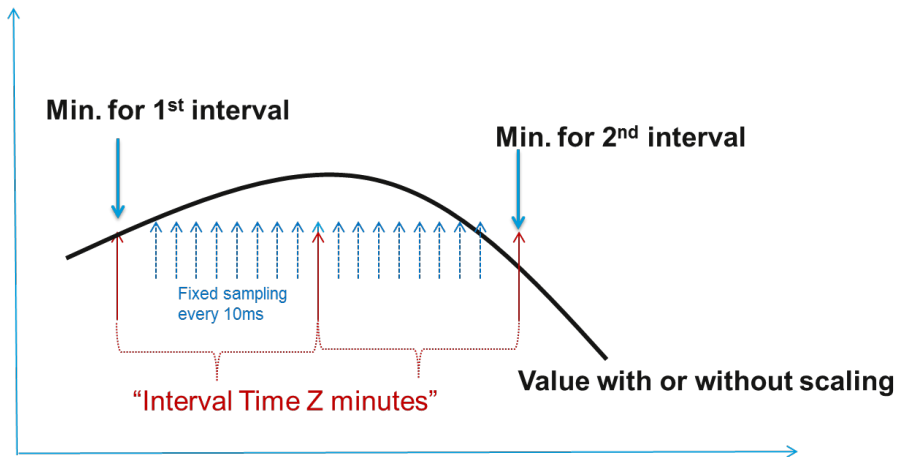



**Average:**

The average value within Z sec, with sampling done every 10 ms.

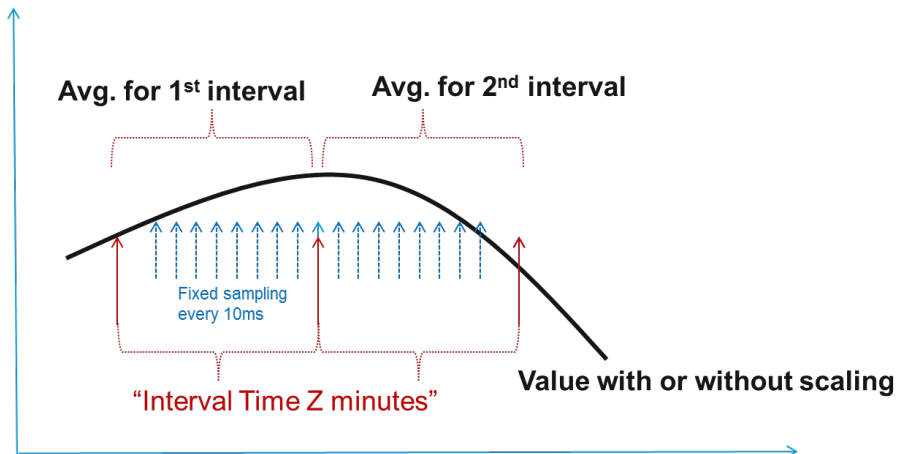

**Instantaneous:**

The instantaneous value when a sample is taken.

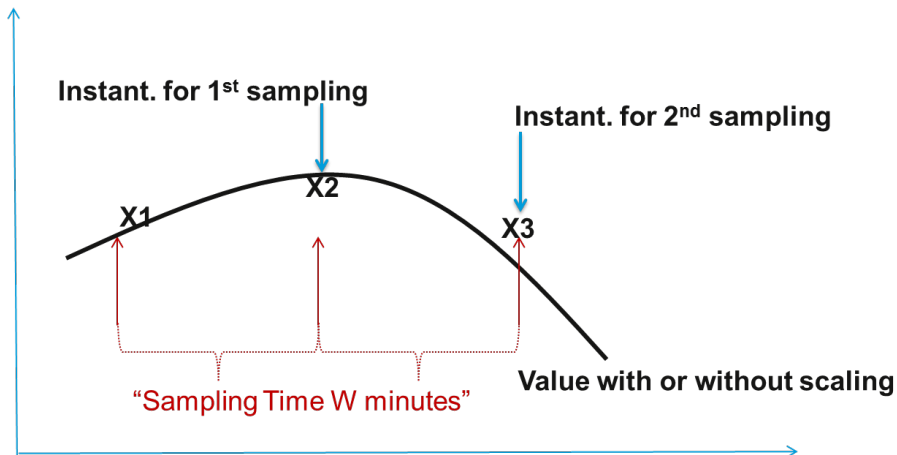

**Incremental:**

The difference ( $\Delta$ ) between two samples.

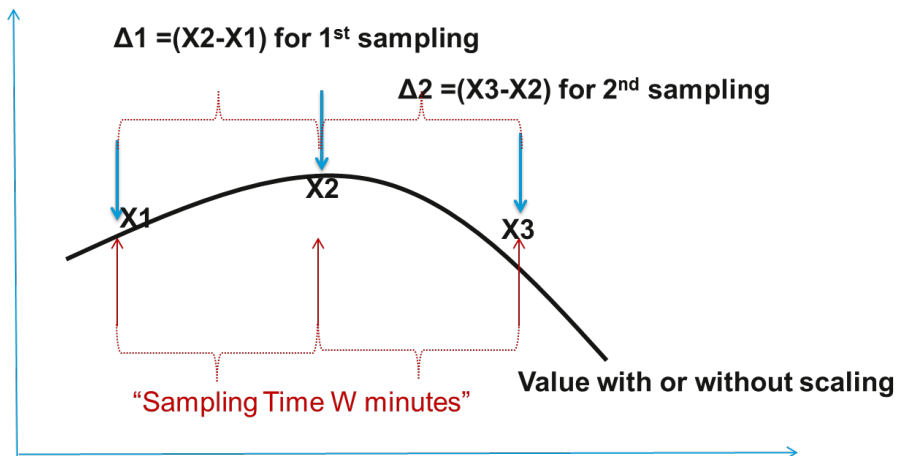

**Accumulation:**

The sum ( $\Sigma$ ) of all sampling values.

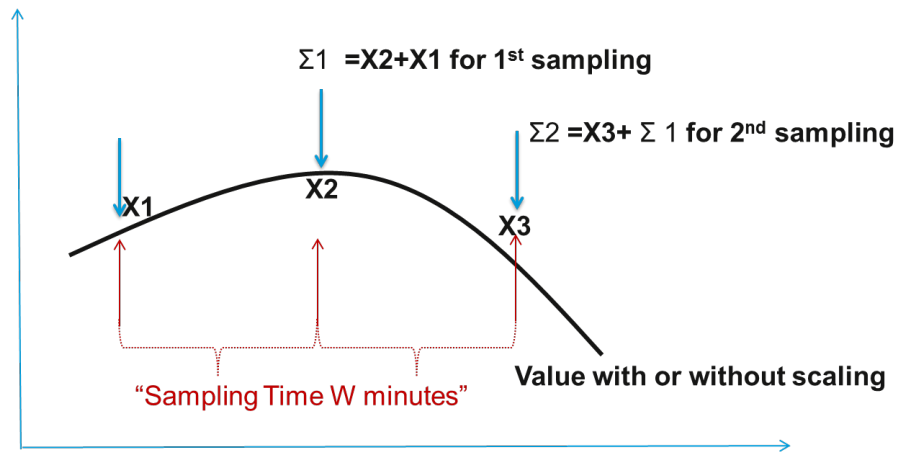

- **Interval (min.)**  
Set the interval time (Minutes) for Maximum, Minimum, and Average functions.
- **Sampling Time (min.)**  
Set the sampling time (Minutes) for Instantaneous and Incremental functions.

## SNMP

The ioLogik supports SNMP (Simple Network Management Protocol) v1, v2c, and v3 to monitor network and I/O devices with SNMP Network Management software. It is useful in building automation and telecom applications. Use these fields to enable SNMP and set the read and write community strings for SNMPv1 and SNMPv2c, or use authentication for SNMPv3.

Enable SNMP

Version: V1 and V2c and V3

Contact:

Location:

SNMP V1, V2c

Read Community: public

Write Community: private

SNMP V3 Read Only

User Name:

Authentication Protocol: DISABLE

Authentication Password:

Privacy Protocol: DISABLE

Privacy Password:

SNMP V3 Read/Write

User Name:

Authentication Protocol: DISABLE

Authentication Password:

Privacy Protocol: DISABLE

Privacy Password:

## Modbus

In this section, I/O addresses can be configured for different formats. Select the **Enable Modbus Service** checkbox, select the Modbus function, and then configure the start address of each item.

No.	Slot No.	Description	Point Type	Read/Write	Start Address (DEC)	Reference Address (DEC)	Total Channels
0	[Slot 00 Mo...	DI Value	02: INPUT STATUS	Read Only	0	10001	8
1	[Slot 00 Mo...	DI Counter Value	03: HOLDING REGI...	Read/Write	0	40001	8
2	[Slot 00 Mo...	DIO Value	01: COIL STATUS	Read/Write	0	00001	8
3	[Slot 00 Mo...	DIO Counter Value	03: HOLDING REGI...	Read/Write	100	40101	8
4	[Slot 00 Mo...	DIO Pulse Status	01: COIL STATUS	Read/Write	100	00101	8
5	[Slot 00 Mo...	Internal Register	03: HOLDING REGI...	Read/Write	500	40501	48
6	[Slot 00 Mo...	Float Internal Register	03: HOLDING REGI...	Read/Write	1000	41001	48
7	[Slot 00 Mo...	DI Counter Start/Stop	01: COIL STATUS	Read/Write	1200	01201	8
8	[Slot 00 Mo...	DIO Counter Start/Stop	01: COIL STATUS	Read/Write	1300	01301	8
9	[Slot 00 Mo...	P2P Connection Status	02: INPUT STATUS	Read Only	1400	11401	16
10	[Slot 00 Mo...	Virtual Channel Value	04: INPUT REGISTER	Read Only	1500	31501	10
11	[Slot 00 Mo...	Reset DI Counter	01: COIL STATUS	Read/Write	1600	01601	8
12	[Slot 00 Mo...	Reset DIO Counter	01: COIL STATUS	Read/Write	1700	01701	8
13	[Slot 00 Mo...	Clear Safe Mode	01: COIL STATUS	Read/Write	1800	01801	1

### Enable Modbus Service

Enable/Disable the Modbus service setting to turn the Modbus/TCP slave protocol on or off.

### Enable host connection timeout

Enable the host connection timeout setting to monitor the Modbus connection status between the Modbus Master and the ioLogik 2500 Modbus service. The connection status can be a condition of a Click&Go Plus rule.

### Restore Default

Click the Restore Default button to restore default settings of the Modbus service.

## AOPC

Moxa MX-AOPC Server is a software package operated as an OPC driver of an HMI or SCADA system. It offers seamless connection from Moxa ioLogik series products to SCADA systems.

### Server Connection

You can set the ioLogik 2500 to connect to MX-AOPC UA Server. Each ioLogik 2500 series can connect to two MX-AOPC UA servers. You can also set different modes to send active tags.

The screenshot shows the configuration interface for connecting to an AOPC Server. At the top, there is a checkbox labeled "Enable connection to AOPC Server with heartbeat interval" which is checked, followed by a text input field containing "30" and the unit "sec(s)". Below this is a section titled "Server Mode" containing three radio button options: "Single Server" (selected), "Dual Server", and "Failover". To the right of these options are input fields for "1st AOPC Server" (0 . 0 . 0 . 0), "2nd AOPC Server" (0 . 0 . 0 . 0), and "Port" (9900). Below the radio buttons are two more input fields: "Retry Times" (3) and "Retry Interval" (3) with the unit "sec(s)". At the bottom, there is a section titled "Data buffer for network failure" with a "Maximum" input field (20) followed by the text "x 1,000,000 records (1 to 20, default: 20)". A note below this section states: "Note: the shortest interval for recording each tag in data buffer is 5 seconds".

### Enable connection to AOPC Server with heartbeat interval

The **Heartbeat Interval** can be used to determine the connection status between the ioLogik 2500 and MX-AOPC Server, and to ensure that the ioLogik 2500 is connected and alive. If the heartbeat interval is set and the network between the ioLogik 2500 and MX-AOPC Server is down, MX-AOPC Server will detect the stopped heartbeat and the Quality column in the MX-AOPC Server will display BAD to indicate the loss of connectivity.

### Server Mode

The ioLogik 2500 can send active tags to one or two MX-AOPC UA servers. You may choose one of three server modes.

#### 1st AOPC Server

IP address of the 1st AOPC server.

#### 2nd AOPC Server

IP address of the 2nd AOPC server.

#### Single Server

The ioLogik 2500's active tags will be sent to a single AOPC server.

#### Dual Servers

The ioLogik 2500's active tags will be sent to two AOPC servers.

#### Fail Over

The ioLogik 2500 will try to connect with the first MX-AOPC Server IP. If it cannot connect, it will automatically connect with the second IP, and when the connection to the second IP fails, it will switch back to the first IP.

## Data buffer for network failure

The ioLogik 2500 supports a data buffer function to store data that was transmitted when the connection between MX-AOPC UA Server and the ioLogik 2500 was down. MX-AOPC UA Logger will automatically retrieve the buffering data after the connection between MX-AOPC UA Server and the ioLogik 2500 is back up and running. Refer to the MX-AOPC UA Server and Logger user's manuals for details.

## Tag Selection

Use tag selection to select which active tags will be updated to MX-AOPC UA server.

Select Module		All		Select All	Unselect All	Apply to All
I/O Type		DI				
Slot No.	Channel No.	Name	Description	On Change		
<input type="checkbox"/>	[Slot 00 Model: 2542-HSPA]	4	DIO-00	Desc	Enabled	
<input type="checkbox"/>	[Slot 00 Model: 2542-HSPA]	5	DIO-01	Desc	Enabled	
<input type="checkbox"/>	[Slot 00 Model: 2542-HSPA]	6	DIO-02	Desc	Enabled	
<input type="checkbox"/>	[Slot 00 Model: 2542-HSPA]	7	DIO-03	Desc	Enabled	
<input type="checkbox"/>	[Slot 00 Model: 2542-HSPA]	8	DIO-04	Desc	Enabled	
<input type="checkbox"/>	[Slot 00 Model: 2542-HSPA]	9	DIO-05	Desc	Enabled	
<input type="checkbox"/>	[Slot 00 Model: 2542-HSPA]	10	DIO-06	Desc	Enabled	
<input type="checkbox"/>	[Slot 00 Model: 2542-HSPA]	11	DIO-07	Desc	Enabled	
<input type="checkbox"/>	[Slot 00 Model: 2542-HSPA]	12	DIO-08	Desc	Enabled	
<input type="checkbox"/>	[Slot 00 Model: 2542-HSPA]	13	DIO-09	Desc	Enabled	
<input type="checkbox"/>	[Slot 00 Model: 2542-HSPA]	14	DIO-10	Desc	Enabled	
<input type="checkbox"/>	[Slot 00 Model: 2542-HSPA]	15	DIO-11	Desc	Enabled	

### Select Module

Use the select module function to check the ioLogik 2500 and its IO expansion modules. If you select **All**, all modules will be selected.

### I/O Type

Select the type of data you would like to record. Choose from DI, Counter, DO, Pulse, AI, Internal Register, Virtual Channel, Serial Tag, and RSSI (cellular models only).

### Select All/Unselect All

You may select all channels, or deselect all channels.

### Apply to All

You can apply one parameter to all channels. For example, if you can change **On Change** from **disabled** to **enabled** and then click **Apply to All**, all AI channels will be enabled.

### Update Method

- **On Change for DI/DO/Pulse/System Tags:** The ioLogik will update the tag value to MX-AOPC UA Server whenever the tag status changes.
- **On Change for AI Tag:** If the AI is configured to update on change, the percentage settings represent the percentage of the full analog range. For example, if the AI is configured to 0 to 10 V, "On Change 1%" means the ioLogik will update to the MX-AOPC Server every time there is 0.1 V change.
- **Interval for Counter/AI/RTD/TC/IR/FIR/VC/Serial Tags:** The ioLogik will update the tag value to MX-AOPC UA Server when the interval time elapses. The interval time can be configured to between 1 and 65535 seconds; the default is 5 seconds.

**NOTE** A shorter interval time may cause a large number of data packets to be generated, resulting in higher data fee if you are using a pay-by-packet connection plan. The ioLogik might also experience higher system loading and unstable performance.

## Serial Port (Port1/Port2)

The ioLogik 2500 supports two serial ports for connecting to serial devices. For serial wiring instructions, check the section **Installation → Serial Communication**.

### Port Settings

Use port settings to set the serial port's parameters.

Port Settings			
Mode	RS-232	Flow Control	None
Baudrate	115200	Data Bits	8
Stop Bits	1	Parity	None

#### Mode

Supports RS-232/RS-422/RS-485

#### Baudrate

Supports 300, 1200, 2400, 4800, 9600, 19200, 38400, 57600, 115200 bps

#### Stop Bits

Supports 1, 2

#### Flow Control

Supports None, RTC/CTS, XON/XOFF

#### Data Bits

Supports 5, 6, 7, 8

#### Parity

Supports Even, Odd, None

### Operation Mode

Each port supports 4 operation modes: Transparent Serial Tunnel (TCP Client), Transparent Serial Tunnel (TCP Server), MODBUS TCP Gateway, and Modbus Serial Tag.

#### Transparent Serial Tunnel (TCP Client/Server)

Transparent Serial Tunnel mode can create a TCP socket to a remote host program and transparently send and receive data to attached legacy serial devices.



- **Transparent Serial Tunnel (TCP Client)**

Operation Mode

Mode:

Remote Address:

Remote Port:

- **Remote Address:** The IP address of the remote host program.
- **Remote Port:** The TCP port of the remote host program (1 to 65535; default = 1)

- **Transparent Serial Tunnel (TCP Server)**

Operation Mode

Mode:

Listen Port:

Idle Timeout:  min

- **Listen Port:** The TCP port of the ioLogik for the remote host program to establish a connection (1 to 65535; default = 4001).
- **Idle Timeout:** The idle timeout for the ioLogik to disconnect the TCP connection (1 to 65535 min(s); default = 10).

**Modbus TCP Gateway**

This function allows users to attach a serial Modbus/RTU meter to the ioLogik 2500's serial port.

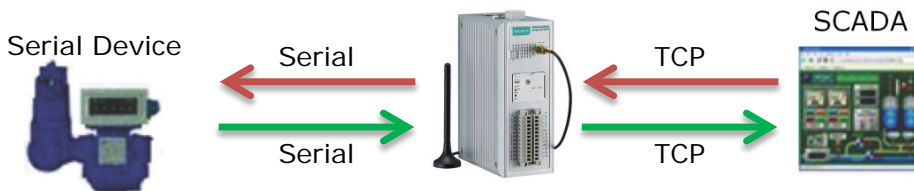

- **Modbus TCP Gateway**

Operation Mode

Mode:

Serial Response Timeout:  ms

- **Serial Response Timeout:** The timeout setting for waiting for a response from a connected serial device (30 to 65535 ms; default = 2500).

**Modbus Serial Tag**

This function allows users to attach a serial Modbus/RTU meter to the ioLogik 2500's serial port and create the serial tags in the MX-AOPC UA Server so that a SCADA system can access this serial data directly via OPC connections.

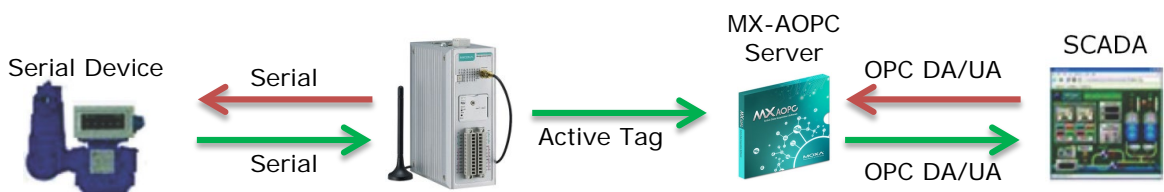

- **Modbus Serial Tag**

Operation Mode

Mode:

Timeout Setting (sec(s)):

No.	Tag Name	Data Type	Data Conversion	Device ID	Start Address	Function Code
0	Tag1	Float	LoWord & HiWord	1	2500	03: Read Holding Registers
1	Tag2	Float	HiWord & LoWord	1	2600	03: Read Holding Registers

Name:

Data Type:  Data Conversion:

Device ID:  Start Address:

Function Code:

- **Timeout Setting:** The timeout setting for the ioLogik to wait for a response from a connected serial device when polling Modbus registers (1 to 65535 sec(s); default = 5).
- **Name:** Specify a name for the serial tag.
- **Data Type:** Select the data type assigned to the serial tag (options: Boolean, WORD, DWORD, Float).
- **Device ID:** Set the device id of the connected serial device.
- **Function Code:** Select the function code for ioLogik to poll this Modbus register (options: "01: Read Coil Status," "02: Read Input Status," "03: Read Holding Registers," "04: Read Input Registers.")
- **Data Conversion:** If the data type of the serial tag is WORD, and the function code is 03 or 04, the serial tag can be set to "HiByte & LoByte" or LoByte & HiByte." If the data type of the serial tag is DWORD or Float, and the function code is 03 or 04, the serial tag can be set to "HiWord & LoWord" or LoWord & HiWord."
- **Start Address:** Define the start address of the Modbus register for the ioLogik to poll.
- **Add:** Click the add button after you finish the above settings.
- **Apply:** Click the serial tag you want to modify, change the settings of this serial tag, and then click the apply button to make it effective.
- **Delete:** Click the serial tag you want to delete, and then click delete button to delete this serial tag.



### ATTENTION

If the Serial Tunnel setting is used in ioLogik 2500 cellular models, the network should be set to **Cellular Always On** (under: Settings → Network → General → Select Network Interface). Otherwise, the Cellular connection will disconnect and a serial tunnel will not be created.



## Data Logging

Install a microSD card in the ioLogik 2500 to use the ioLogik 2500's data logging function. When the function is activated, the following values will be logged: **I/O channels**, **Internal registers**, **virtual channels**, and **serial tags**.

### Profile

A total of 10 profiles can be created, and multiple/duplicate channels can be included in different profiles.

**Step1:** Define how to log the data by specifying the Logging Type. Users can choose to log from different I/O channels.

**Step2:** Check mark I/O channels that you would like to add in the profile, and click **Add** to create a profile.

**Step3:** Click **Apply** to save the profile settings.

Timestamp column:  Device local time  UTC and time zone

No.	Profile Name	Initial State	Total Profile Size (MB)	Records Pe...
0	DATALOG	Disabled	512	1000

**Profile Settings**

Name:

Enable at Power On

Total Profile Size in MB (512 to 32768):  Records Per File (1000 to 65000):

Select Tag

Select Module:

I/O Type:

	Slot No.	Channel No.	Name	On Change	Percentage (%)	Interval
<input type="checkbox"/>	[Slot 00 Model: 2542]	0	AI-00	Disabled	50	Enabled
<input type="checkbox"/>	[Slot 00 Model: 2542]	1	AI-01	Disabled	50	Enabled
<input type="checkbox"/>	[Slot 00 Model: 2542]	2	AI-02	Disabled	50	Enabled
<input type="checkbox"/>	[Slot 00 Model: 2542]	3	AI-03	Disabled	50	Enabled

### Timestamp column

Each piece of logged data has a time stamp. The timestamp can be set to **device local time** or **UTC and time zone**.

#### Device Local Time

The ioLogik 2500 will log data using the device's local time, which will be stored in a separate column in the log file.

#### UTC and time zone

The ioLogik 2500 will log the UTC time and time zone, which will be stored in separate columns in the log file.

## Profile Settings

The selected data will be logged in a profile. The profile name will be used as the folder name on the microSD card for storing logged data. The profile settings allow you to select the channel you want to log and configure settings (e.g., Enable at power on and profile Size) for each profile.

The profile is saved to a folder based on the profile name. The filename is based on the creation time.

ftp://IP address of device : port/profile name/yyyy/mmddhhxx.csv

- yyyy: year
- mm: month
- dd: date
- hh: hour (24-hour clock)
- xx: sequence number (00 to 99)

### Name

The profile name will also be used as the folder name on the microSD card for storing logged data.

### Enable at Power On

Enable this function to start data logging at power on. You can also use Click&Go Plus rules to enable/disable the logging features of each profile.

### Total Profile Size

The Total Profile Size sets an upper limit on the amount of data that will be logged. When the limit is reached, the newest data will overwrite the oldest data.

<b>NOTE</b> The total size of the profiles should be less than the size of the microSD card. Otherwise, the data cannot be logged onto the microSD card. 1,000,000 records require about 1 MB of memory space.
--

### Records per File

The Records per File setting sets an upper limit on the number of records allowed per file. When a particular file reaches the maximum number of records, the device will create a new file in the same profile folder and then continue to record data.

## Select Tag

For a given profile, you can select which tags you would like to record.

### Select Module

You can check ioLogik 2500 and its IO expansion module by using the select module function. If you select **ALL**, all modules will be selected.

### I/O Type

You can select the type of the data you would like to record. Types of data that can be recorded include DI, Counter, DO, Pulse, AI, Internal Register, Virtual Channel, Serial Tag.

### Select All/Unselect All

You can select all channels or unselect all channels with a single click.

### Apply to All

You can apply one parameter to all channels. For example, you can change **On Change** from disable to enable and then click **Apply to All**. The On Change enable setting will be applied to all AI channels.

**Log Method**

- **On Change for DI/DO/Pulse/System Tags:** The ioLogik will log tag values to the file whenever the tag status changes.
- **On Change for AI Tag:** If the AI is configured to log on change, the percentage settings represent the percentage of the full analog range. For example, if the AI is configured to 0 to 10 V, "On Change 1%" means the ioLogik will log to file every time there is 0.1 V change
- **Interval for Counter/AI/RTD/TC/IR/FIR/VC/Serial Tags:** The ioLogik will log tag values to file when the interval time elapses. The interval time can be configured to between 5 and 86400 seconds; the default is 5 seconds.

**FTP**

The FTP item defines how to log I/O data to an FTP server. The FTP Service function provides upload service for data log files stored on the MicroSD card.

**FTP Client0 Settings**

IP (or URL) ftp://

Port

Username

Password

Confirm Password

Timeout (ms)

**Enable FTP Server**

Username

Password

Confirm Password

**FTP Client1 Settings**

IP (or URL) ftp://

Port

Username

Password

Confirm Password

Timeout (ms)

**FTP Client Settings**

The device can act as a client to actively send log files to a predefined FTP server address.

**IP (or URL)**

The IP address of the FTP server.

**Port**

The Port number of the FTP server.

**Username**

The username used to log in to the FTP server.

**Password**

The password used to log in to the FTP server.

**Timeout (ms)**

The ioLogik 2500 will disconnect the session when this timeout is reached (100 to 65535 ms; default = 1000).

**FTP Server Settings**

The device can be an FTP server for FTP clients to retrieve logged data. The logged file is read-only.

The address to access data will stored in the following address: ftp://IP address of device : port/profile name/yyyy/mmddhhxx.csv

- yyyy: year
- mm: month
- dd: date
- hh: hour (24-hour clock)
- xx: sequence number (00 to 99)

**Enable FTP server**

To enable or disable the FTP server function.

**Username**

The FTP server's username.

**Password**

The FTP server's password.

<b>NOTE</b>	Default username: admin Default password: moxa
-------------	---

**Click&Go Plus**

Click&Go Plus provides the functional elements that can be used in Click&Go Plus rules, including Timer, SNMP trap, TCP/UDP message, Email, Schedule, Internal Register, Remote Action, and CGI command. You must set all of these elements before you start configuring your Click&Go rules. When a set of rules (known as a rule-set) is defined using Click&Go Plus, the ioLogik can perform local and remote I/O control, report I/O status, and actively send out messages, e-mails, or SNMP traps to a host as soon as the user-defined I/O conditions have been met.

For a detailed introduction on how to use this function, refer to Chapter 2 of the [Click&Go Plus User's Manual](#).

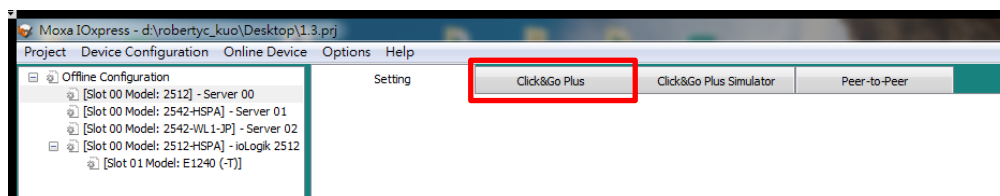
**Click&Go Plus Tab**

Click&Go Plus logic provides an easy way to program your ioLogik 2500 product for smarter I/O functionality over an Ethernet network. For a detailed introduction on how to use Click&Go Plus, refer to Chapter 3 of the [Click&Go Plus User's Manual](#).

## Click&Go Plus Simulator Tab

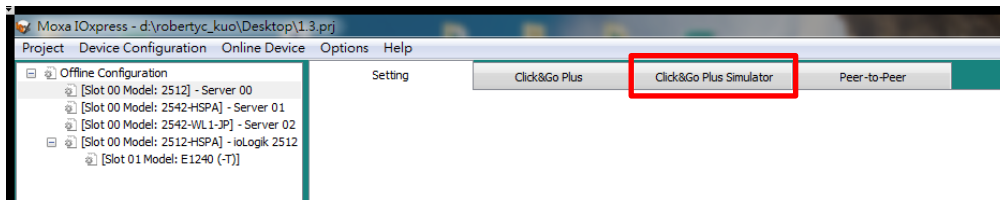

When you finish defining your Click&Go Plus rules, you can use the Click & Go plus Simulation tool to test the rules. For a detailed introduction of how to use this function, refer to Chapter 4 of the [Click&Go Plus User's Manual](#).

## Peer-to-Peer Tab

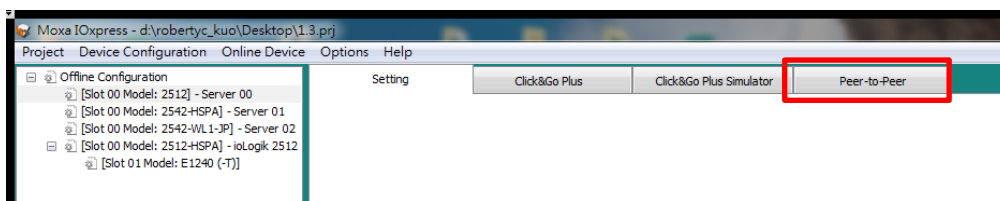

In some remote automation implementations, the control room and field sensors may be located far apart from each other, often with only a single remote I/O module to collect data from all the sensors.

**Peer-to-peer communication** has little or no limitation since it replaces cable by integrating multiple I/O signals over a single network cable to transmit input-to-output controls without the aid of PLCs or controllers.

With peer-to-peer communication and support for channel-to-channel mapping, the ioLogik 2500 allows simultaneous multiple target transmissions. In addition, the ioLogik 2500 supports up to 16 channels for transmission over Ethernet (based on an emitter and receiver I/O pair).

Click on **Peer to Peer** in the menu bar to configure basic device settings.

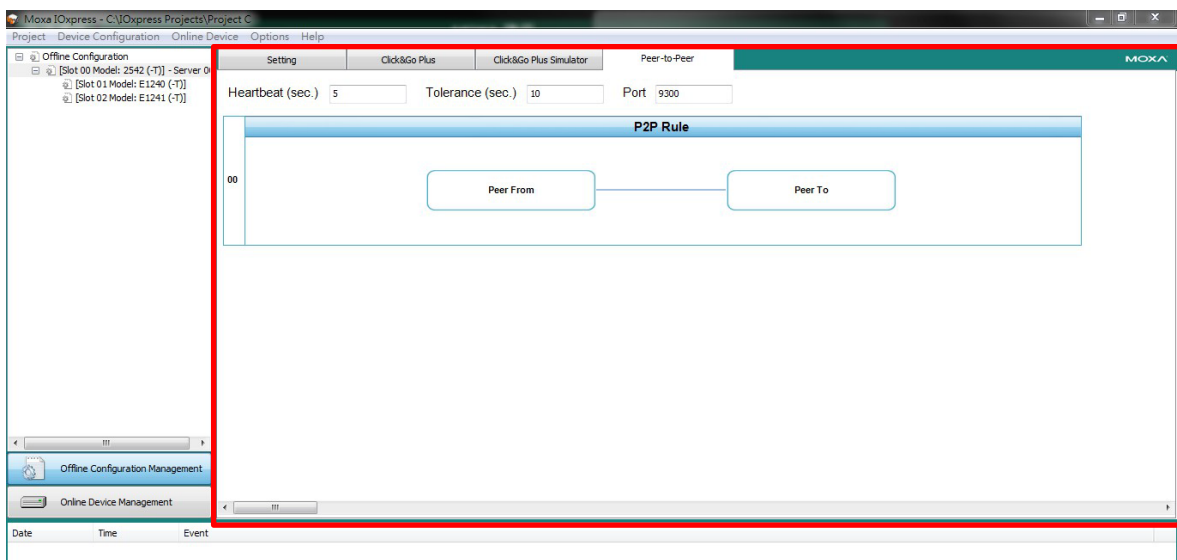

## General Settings

### Heartbeat (Sec)

Heartbeat is used to determine the connection status between Peer-to-Peer devices and to ensure that the ioLogik 2500 is connected and alive (0 to 65535 sec; default = 5).

**NOTE** If the heartbeat interval is set and the network between the Peer-to-Peer devices is down, the ioLogik 2500 will detect lack of heartbeat, and then disconnect the Peer-to-Peer connection.

### Tolerance (Sec)

Tolerance allows you to define an additional timeout interval to wait for a heartbeat signal from Peer-to-Peer devices (0 to 65535 sec; default = 10).

### Port

The listen port of the local ioLogik 2500 device for peer-to-peer function (1 to 65535; default = 9300).

## Peer-to-Peer Rule Settings

With peer-to-peer communication and support for channel-to-channel mapping, the ioLogik 2500 allows simultaneous multiple target transmissions.

In a Peer-to-Peer rule, the ioLogik 2500 can be configured to receive a signal from a remote site and output the signal at the local site, allowing you to configure the remote site information by configuring the IP address, slot index (for expanded E1200 units), and module type.

The image displays two side-by-side screenshots of the 'Peer-to-Peer Rule Settings' dialog box. Both screenshots show the 'Remote' and 'Local' sections, with the 'Criterion' section at the bottom. The left screenshot shows a configuration for a DIO channel type, while the right screenshot shows a configuration for an AI channel type.

Section	Parameter	Value (Left Screenshot)	Value (Right Screenshot)
Remote	IP Address	192 . 168 . 127 . 250	192 . 168 . 127 . 250
	Slot Index	0	0
	Module Type	2542	2542
	Channel Type	DIO	AI
	Channel Index	0	0
Local	Slot Index	[Slot 00 Model: 2512-WL1-US] - Server 03	[Slot 01 Model: E1241 (-T)]
	Channel Type	DIO	AO
	Channel Index	7	0
	Disconnection Mode	Hold Last	Manual
Criterion	On Change	<input type="checkbox"/>	<input type="checkbox"/> 50 %
	Interval	<input checked="" type="checkbox"/> 1000 ms	<input checked="" type="checkbox"/> 1000 ms

## Remote

- **IP Address:** The IP address of the remote device that collects and sends signals.
- **Slot Index:** An integer used to represent the remote ioLogik 2500 and its E1200 expansion units (0: the ioLogik 2500 head unit; 1 to 8: the ioLogik E1200 expansion units).
- **Module Type:** The model name of the remote device.
- **Channel Type:** The input channel type of the remote device.
- **Channel Index:** The input channel index of the remote device.

## Local

- **Slot Index:** The local ioLogik 2500 or its E1200 expansion units.
- **Channel Type:** The output channel type of the local device.
- **Channel Index:** The output channel index of the local device.
- **Disconnection Mode:** The output mode when peer-to-peer disconnection occurs (options for DO: ON, OFF, or Hold Last; options for AO: manual or Hold Last).

## Criterion

- **On change:** Triggers the peer-to-peer signal transmission when the status of the DI channel changes or the value of the AI channel changes by the pre-defined percentage.
- **Interval:** Triggers the peer-to-peer signal transmission when the interval time elapses (500 to 65535 ms; default = 1000).

**NOTE** Up to 16 Peer-to-Peer rules can be set (a set of ioLogik 2500 + up to 8 x ioLogik E1200).

**NOTE** You only need to configure peer-to-peer rules for output channels on the local ioLogik device. The peer-to-peer channels at the remote field site will be mapped to automatically.

# Online Device Management

---

With Online Device Management, the operator uses IOxpress to export the configuration to devices on the network. That is, settings that were configured offline are exported over the network to online devices. This can be done either in batch mode, or on a case-by-case basis.

IOxpress can also be used to access online devices directly to check I/O status, upgrade firmware, export configurations, and restart devices.

The following topics are covered in this chapter:

- ❑ **Introduction**
- ❑ **Auto-Searching for Online Devices**
  - First Time Searching for Devices
  - Conducting another Search for Online Devices
- ❑ **Adding Devices Manually**
  - Add Device by IP Address
  - Add Device by Cellular Data Access
- ❑ **Mass Deployment**
  - Update Configuration to Device
  - Get Configuration from Device
  - Update Firmware
  - Time Sync
  - Retrieve System Log
  - Restart Device
  - Load Factory Default
  - Change IP Address
  - Change Server Name
- ❑ **Web Console**
- ❑ **Web Console Functions**
  - User Interface Introduction
  - System Information Panel
  - Menu Panel and Web Pages



# Introduction

IOxpress provides an **online device management** user interface for ioLogik 2500 units that are deployed online, allowing you to handle all online devices with a single interface.

Online device management can be used to update/export configurations to/from multiple ioLogik 2500 devices. It provides a variety of functions to help you manage multiple devices at the same time, including:

- Update configuration to device
- Get configuration from device
- Update firmware
- Time sync
- Retrieve system log
- Restart Device
- Load Factory Default
- Change IP address
- Change Server Name

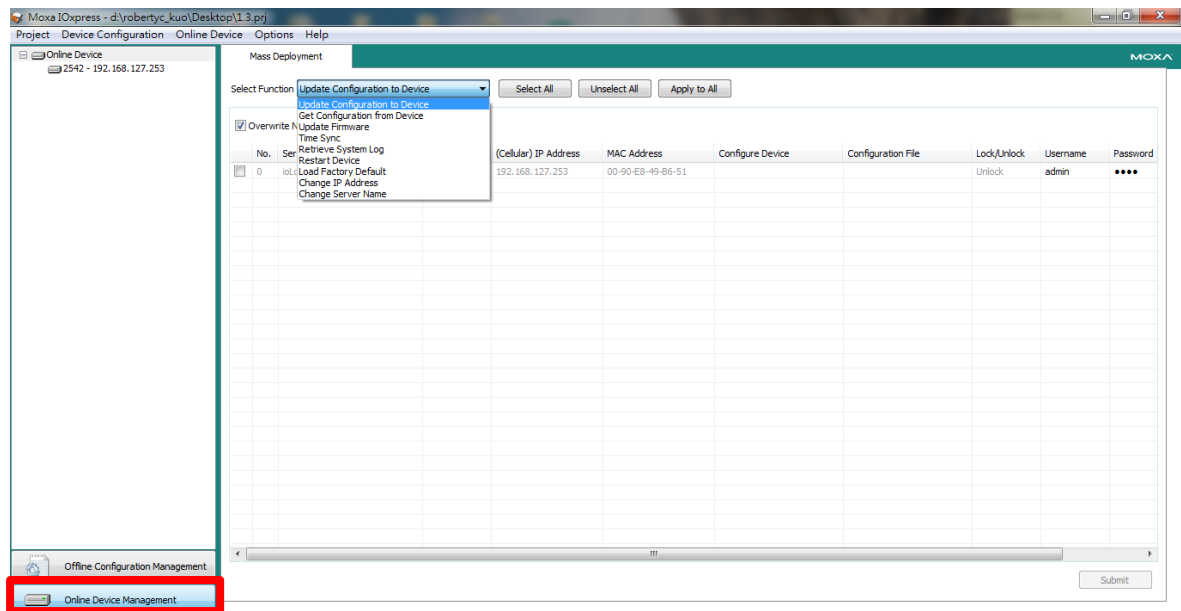

# Auto-Searching for Online Devices

## First Time Searching for Devices

- The first time you click **Online Device Management**, IOxpress will automatically display an auto-search information popup window.
- Click **Yes** to start searching for devices.
- The search information will be displayed in the Log.

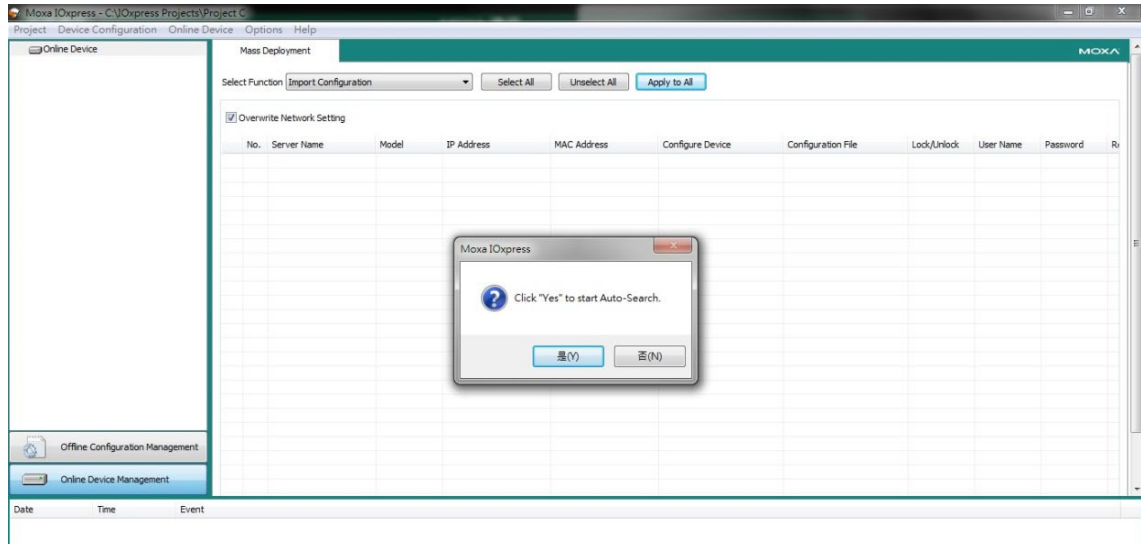

## Conducting another Search for Online Devices

If you would like to conduct another search for online devices, click **Auto-search Device** in the **Online Device** tab in menu bar.

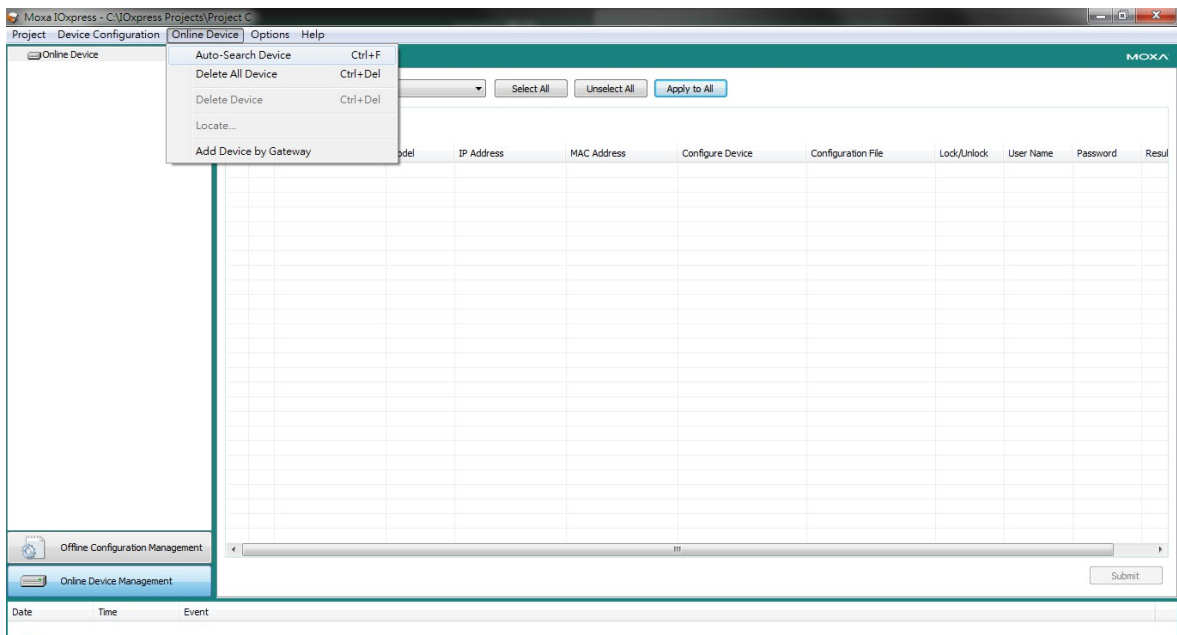

# Adding Devices Manually

Online devices can be added to the online device list manually. Click **Online Device** on the toolbar and then select **Add Device by IP Address** or **Add Device by Cellular Data Access**.

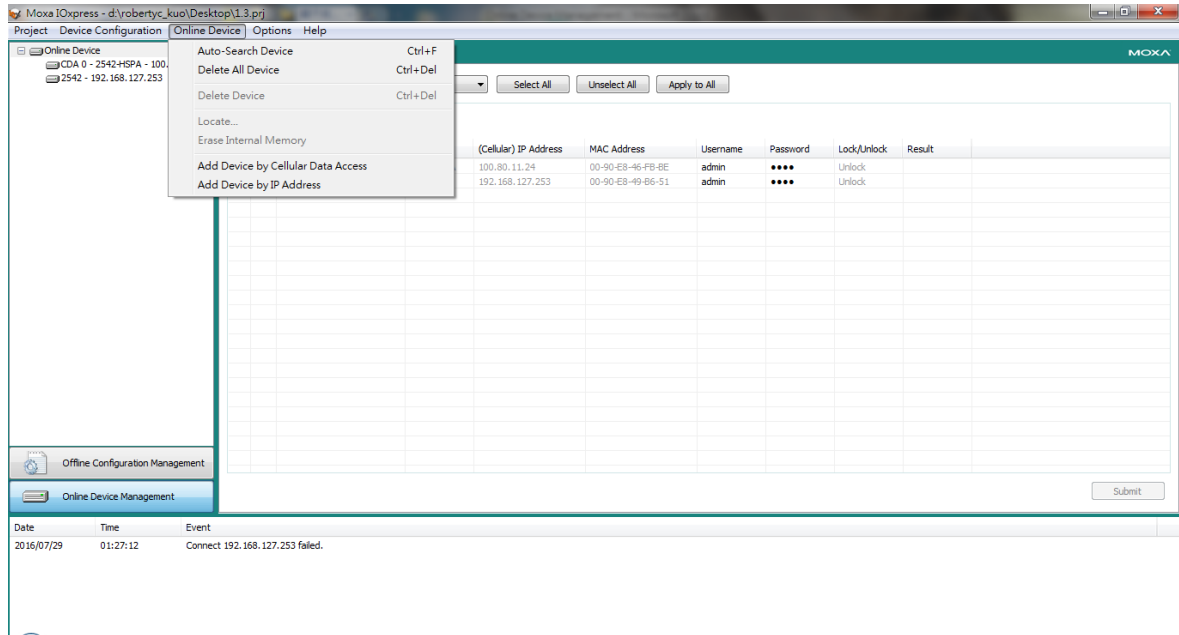

## Add Device by IP Address

The 'Add Device by IP Address' dialog box contains the following fields and buttons:

- IP Address:** A text field with a placeholder showing three dots (.) separated by spaces.
- Username:** A text field.
- Password:** A text field.
- OK:** A button to confirm the device addition.
- Cancel:** A button to cancel the operation.

- Use Add Device by IP Address to add a device with a fixed IP address.
- You must enter a **Username** and **Password** for the device.

## Add Device by Cellular Data Access

Cellular Data Access is a device gateway that allows you to establish connections to ioLogik 2500 units configured with a dynamic public IP. You will need to install Cellular Data Access on a server that is using a public IP address, and the iologik 2500-GPRS/HSPA unit's configuration must have the Cellular Data Access function enabled.

Once the Cellular Data Access and ioLogik 2500 are configured, you can use "add device by cellular data access" to add a device registered in the Cellular Data Access server.

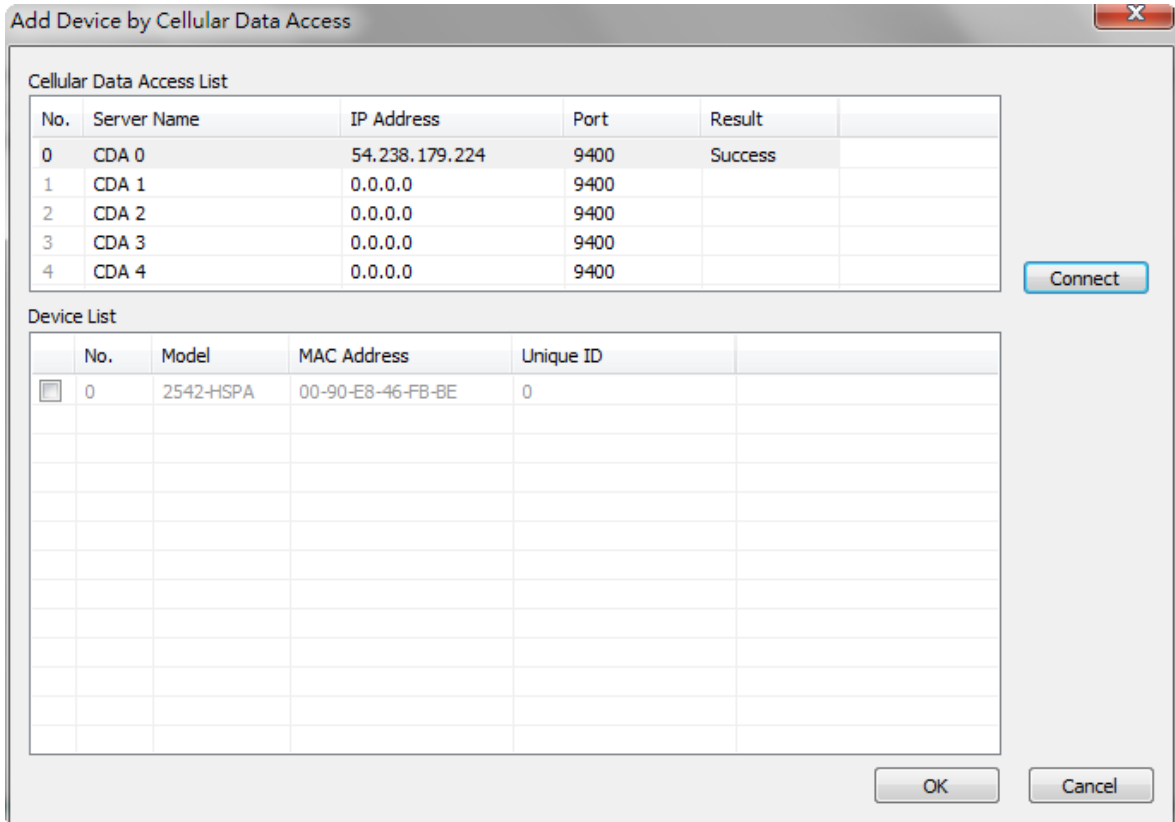

- Type in the IP address of the Cellular Data Access server and then click connect. The registered device will be shown in the device list.
- In the example shown above, an ioLogik 2542-HSPA device is registered in the Cellular Data Access server with IP address 54.238.179.224.

# Mass Deployment

After online devices have been added to the online device list, you can then use mass deployment to deploy the online devices.

Mass deployment allows you to deploy multiple devices at the same time. To execute a mass deployment, first click **Online Device** in the left panel, and then click **Select Function** to open the dropdown box. Ten different functions can be used for mass deployment.

- Update configuration to device
- Get configuration from device
- Update firmware
- Time sync
- Retrieve system log
- Restart Device
- Load Factory Default
- Change IP address
- Change Server Name

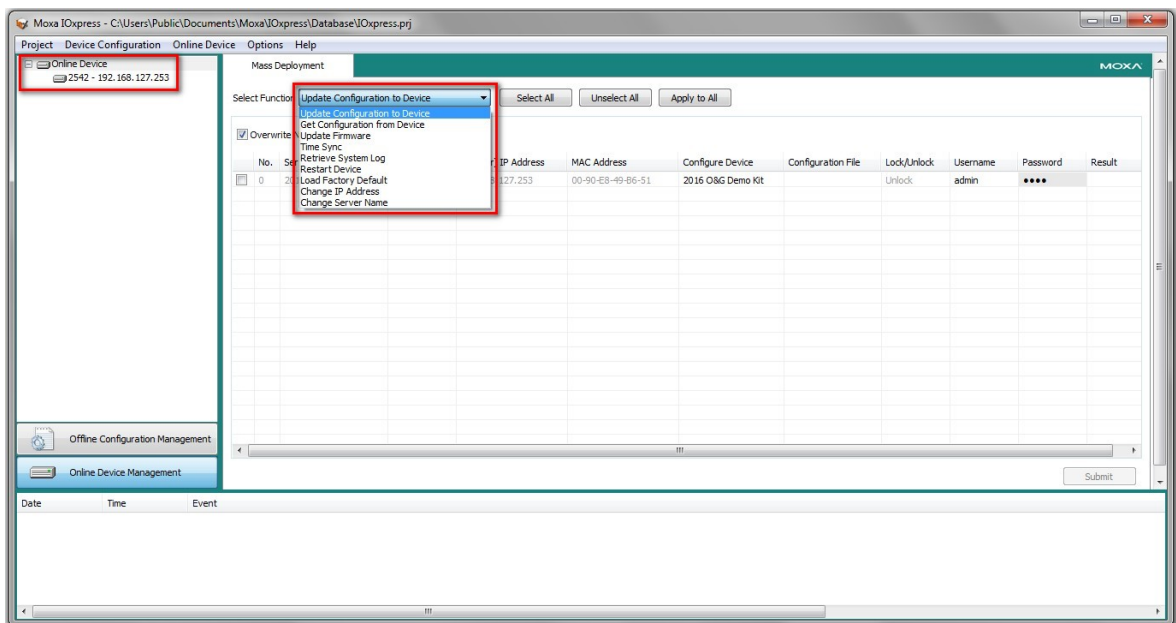

**NOTE** If you do not want to change a device's network settings, uncheck the **Overwrite Network Setting** checkbox.

**Overwrite Network Setting**

In the following subsections, we describe in greater detail how to use these functions.

Update Configuration to Device  
 Get Configuration from Device  
 Update Firmware  
 Time Sync  
 Retrieve System Log  
 Restart Device  
 Load Factory Default  
 Change IP Address  
 Change Server Name

## Update Configuration to Device

Use this function to update configurations that were completed using **Offline Configuration Management**. The ioLogik's system configuration, including the current Click&Go Plus rule-set, can be imported and exported to the ioLogik 2500 device. You will need to know the user name and password to use this function.

The configuration can be from one of two sources:

### Configurations from Offline Configuration Management:

To update a configuration completed in Offline Configuration Management, click the **Configure Device** column and select the configuration you created.

(The configuration name will be shown using the **Device Name** that was set during the offline configuration.)

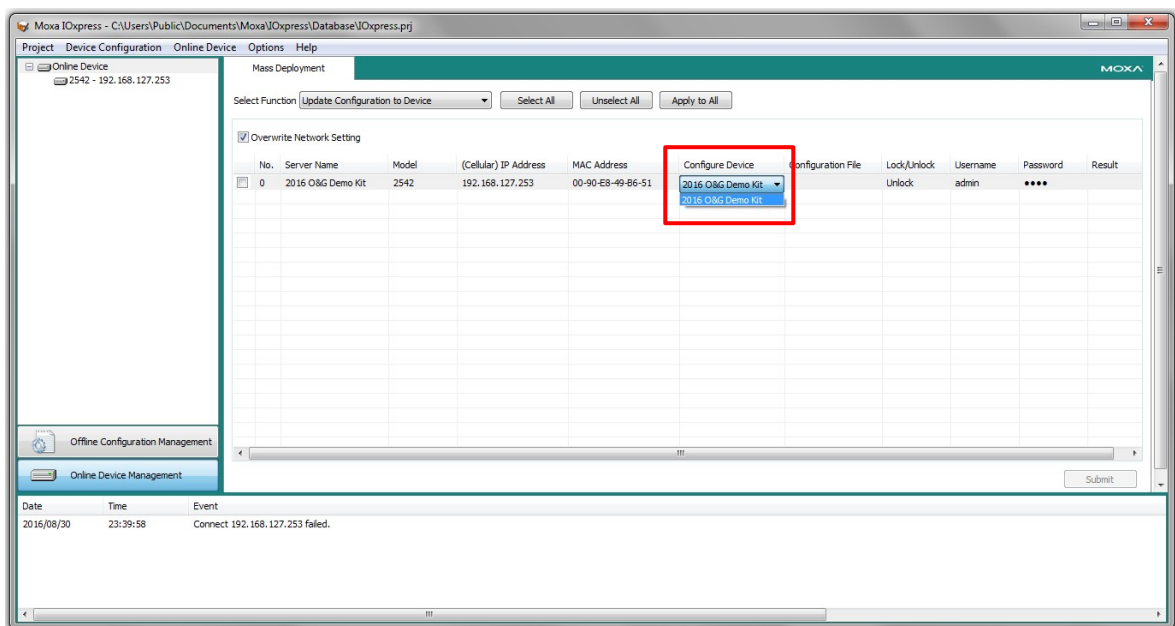

### Configurations from a Configuration File:

You can update a configuration from a configuration file saved on your computer.

**NOTE** If the device is Locked, you must log in as administrator to gain access to the ioLogik's configuration options. If you have not updated the username and password, use the defaults:

Default User Name: admin  
 Default password: moxa

## Get Configuration from Device

You can get the configuration from an ioLogik 2500 unit and save the configuration to your PC.

## Update Firmware

The **Firmware Update** tab is available after you log in as administrator. Enter the path to the firmware file or click on the icon to browse for the file. Click **Update** to update the ioLogik firmware. The wizard will lead you through the entire process, including restarting the ioLogik.

## Time Sync

The ioLogik 2500 can be synchronized with PC time, or the time can be set manually. However, regardless of whether the time was synchronized with PC time or was set manually, the ioLogik 2500 will continue to connect to an NTP server periodically. Consequently, the time will be updated the next time the ioLogik 2500 connects to the NTP server.

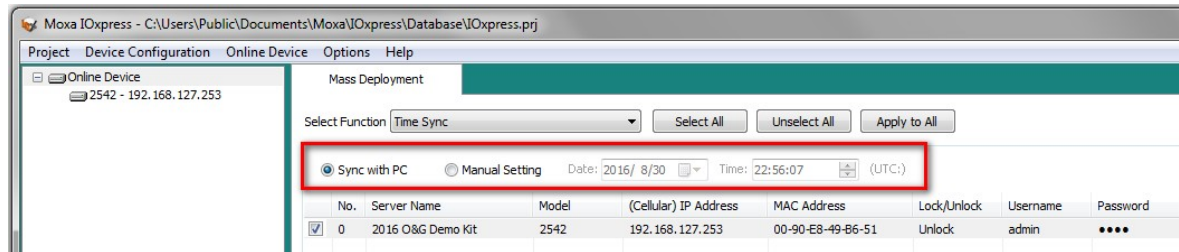

## Retrieve System Log

The ioLogik 2500 will log the system's status in the device. When needed, you can retrieve the system logs and send the logs to the Moxa support team for further analysis. Since the system log is designed to be analyzed by the Moxa support team, the log will be encoded.

## Restart Device

Select this command to restart a selected ioLogik 2500.

## Load Factory Default

Select this command to reset all settings on the selected ioLogik, including the password and all configuration settings, to factory default values.

## Change IP Address

Use this function to change the IP address of an ioLogik 2500.

## Change Server Name

Use this function to change the server name.

## Web Console

Use the web console to check the device status. There are two ways to connect to the ioLogik 2500 web console.

### **By Browser**

The ioLogik 2500 series can be accessed using Internet Explorer (version 9 or above), Firefox, or Google Chrome to check device status. Type the ioLogik 2500's IP address in the browser's address box to access the unit.

**By IOxpress**

Open the IOxpress graphical user interface and then select the device you would like to check. IOxpress leverages the version of IE installed on your PC to display information about connected devices. In order to ensure that the information is displayed correctly, please ensure that version 9 or above of Microsoft Internet Explorer is installed on your computer.

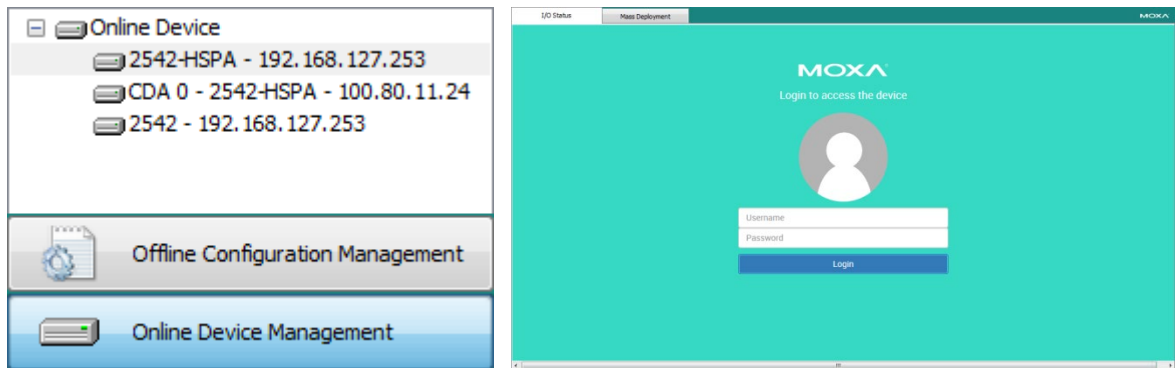

**NOTE**

- Default user name: admin
- Default password: moxa

Note: The user name and password are **case-sensitive**.

## Web Console Functions

You can check the device status and also import/export configurations from the web console. The following section introduces how to use these web console functions.

## User Interface Introduction

The web console is divided into three regions:

1. System information panel
2. Menu panel
3. Web page panel (the web page associated with the function selected in the Menu panel)

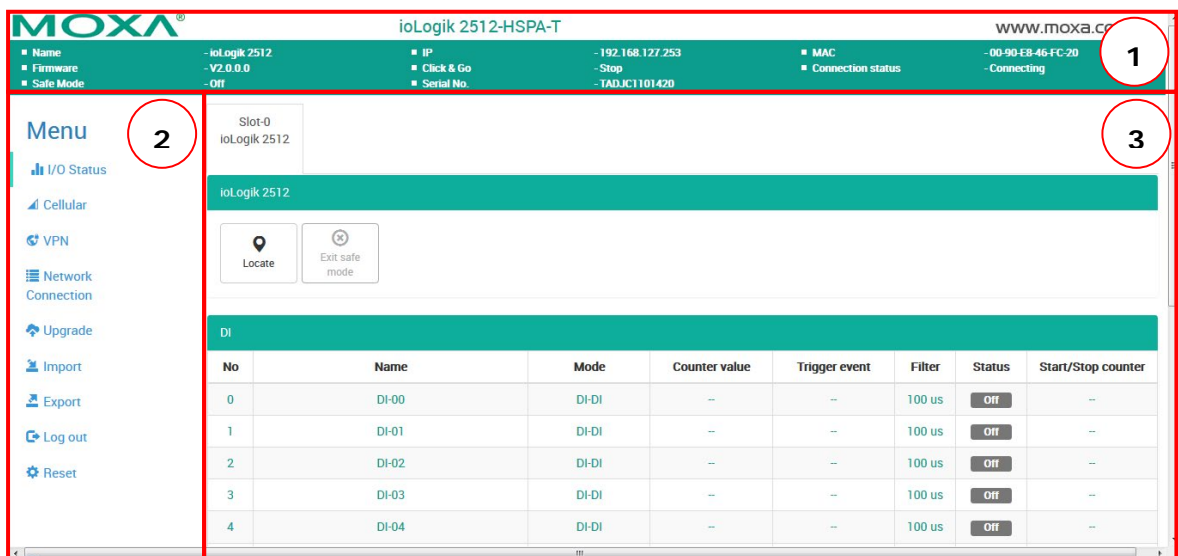



## System Information Panel

The system information panel displays the ioLogik 2500’s system information, including Name, Firmware versions, IP address, Click&Go status, serial number, MAC address, and connection status.

## Menu Panel and Web Pages

The menu panel includes the following items.

### I/O Status

Click **I/O Status** to check the I/O status of the ioLogik 2500 and its expansion modules. The Web page panel should appear similar to figure shown at the right. The number of “slots” that appear will depend on the number E1200 modules connected to the ioLogik 2512.

- Click any of the slots (Slot-0, Slot-1, ..., Slot-8) to check the I/O status of the device.
- Use the **Locate** function to identify the physical location of the selected device. The device’s RDY LED will continuously blink green.
- Use the DI/Counter channels to check the DI/Counter status and reset/start/stop the counter.

DI							
No	Name	Mode	Counter value	Trigger event	Filter	Status	Start/Stop counter
0	DI-00	DI-DI	--	--	100 us	Off	--
1	DI-01	DI-Counter	0 <input type="button" value="Reset"/>	Low to High	100 us	Stop	<input type="button" value="Start"/> <input type="button" value="Stop"/>

- Use the DO/Pulse channels to manually control the DO/Pulse.

DO							
No	Name	Mode	ON width	OFF width	Pulse count	Status	Start/Stop pulse
8	DIO-00	DIO-DO	--	--	--	Off	<input type="button" value="On"/> <input type="button" value="off"/>
9	DIO-01	DIO-Pulse	100 us	100 us	0	Stop	<input type="button" value="Start"/> <input type="button" value="Stop"/>

### Cellular (ioLogik 2500-GPRS/HSPA only)

Use this function to identify the cellular connection status of ioLogik 2500-GPRS/HSPA units.

- There are four cellular connection stages. While a particular stage is in process, the icon of the stage will be green.

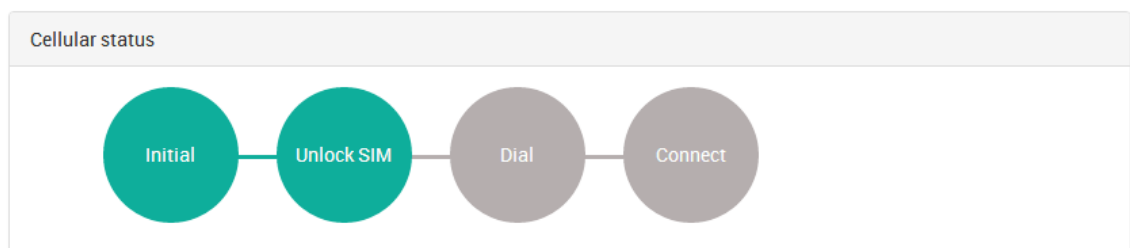

- The cellular information provides the IMEI and RSSI of the cellular connection.
- Once the IP and DNS are received from the ISP, the network information will shown.
- SIM Information shows the current status of the SIM card.

Cellular Info.	
IMEI	358625050016080
RSSI	99 

Network Info.	
IP	None
DNS	None

SIMs Info.	
SIM-1	<span style="background-color: green; color: white; padding: 2px;">Using</span> Cannot Found
SIM-2	Cannot Found

### VPN Status (ioLogik 2500-GPRS/HSPA only)

Use this function to identify the VPN connection status of ioLogik 2500-GPRS/HSPA units.

- You can check VPN status. There are four cellular connection stages. While a particular stage is in process, the icon of the stage will be green.

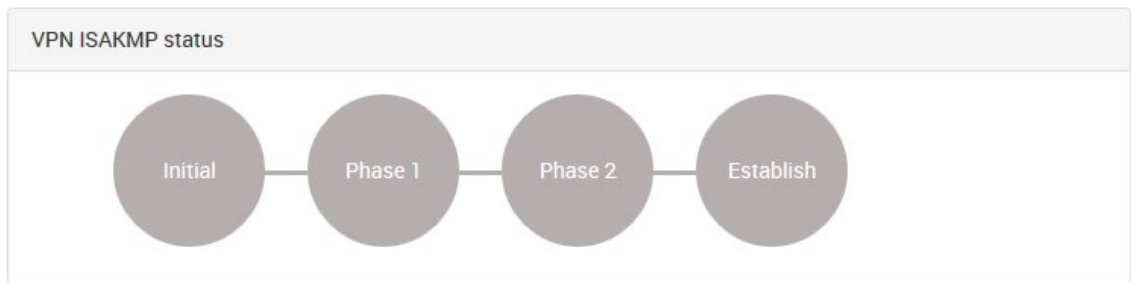

### Upgrade

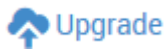

Click this icon to upgrade the firmware. You can choose the FWR file you would like to use for the upgrade.

### Import



Click this icon to import a device configuration. You can choose the config file you would like to use for the upgrade.

### Export



Click this icon to export a device configuration.

### Reset



Click this icon to reset the device to factory default.

# 6

## Cellular Network Setup and Configuration (for cellular models)

---

In this chapter, we introduce how to set up your ioLogik 2500-GPRS/HSPA device.

The following topics are covered in this chapter:

### ▣ **IOxpress Settings for a Cellular Network**

- Select Network Interface
- Cellular

### ▣ **Cellular Network Connection**

- MX-AOPC Server (for SCADA/HMI users)
- With DDNS (for SCADA/HMI users)
- Moxa Cellular Data Access Utility (for mobile devices/PCs)

# I Opress Settings for a Cellular Network

When you add an ioLogik 2500-GPRS/HSPA model, the following two functions will be available (in addition to the functions discussed in Chapter 3).

## Select Network Interface

Configure your device's cellular network settings on the **Select Network Interface** page, which is located under the **Network-General** sub-page.

**Select Network Interface**

Cellular Only

Cellular Always On

Cellular On Demand

By Click&Go Plus

Wake On Call

Index	Phone Number
0	
1	
2	
3	
4	

LAN as Primary and Cellular as Backup

Dest.   
(AOPC Server or any public URL)

Continuous check until  fails (1 to 255)

Retry Interval  (10 to 600 sec(s))

**General Settings**

Enable Web Console

Enable Server Socket Idle Connection Timeout (sec(s))

Private IP for the First Expansion Module

## Cellular Only

You can configure under what conditions the ioLogik 2500-GPRS/HSPA will connect to the cellular network. For example, the device could be triggered by a Click&Go Plus rule or by wake on call.

## Cellular Always On

This mode allows the ioLogik 2500-GPRS/HSPA to always remain connected to the cellular network.

## Cellular ON Demand

This mode allows the ioLogik 2500-GPRS/HSPA to conserve power by flipping into sleep mode whenever there is no need to transmit information. When in sleep mode, the ioLogik 2500-GPRS/HSPA disables the cellular connection and stays in standby mode, saving all I/O records in the data log on the SD card. The ioLogik 2500-GPRS/HSPA will only wake up when either:

1. It receives an activate message from Click&Go, or
2. It receives a call from an authorized caller phone number.

## LAN as Primary and Cellular as Backup

By selecting this function, a remote destination is used in this setting to indicate if the Internet connection is still alive. The user can specify a public IP or URL and the number of retries that are allowed. If the Ethernet is disconnected, the cellular connection will be triggered as a backup.

### Dest IP/URL

This option, which can be configured to either an AOPC server IP or any public URL, will be used by the device to determine whether or not it is connected to the Internet.

### Continuous Check Until 3 failures

The ioLogik 2500-GPRS/HSPA continuously check its connection with the IP/URL to ensure that it is constantly connected to the internet (could incur a high cost, depending on your cellular plan).

### Retry Interval

The "retry interval" is the time interval between retries.

## Cellular

Cellular network settings are configured on the "cellular" page, which is located under "Network."

### General

To set up your cellular connection, click the **Cellular Settings** tab and enter your **User name**, **Password**, **SIM pin code**, and **APN** of your Cellular Provider (contact your local Cellular Service Provider for assistance).

Cellular Data Network Settings (SIM1)		Cellular Data Network Settings (SIM2)	
Username	<input type="text"/>	Username	<input type="text"/>
Password	<input type="text"/>	Password	<input type="text"/>
SIM PIN	<input type="text"/>	SIM PIN	<input type="text"/>
APN	<input type="text" value="internet"/>	APN	<input type="text" value="internet"/>
Band	<input type="text" value="Auto"/>	Band	<input type="text" value="Auto"/>
PPP Authentication	<input type="text" value="Auto mode"/>	PPP Authentication	<input type="text" value="Auto mode"/>
Dial AT Command	<input type="text" value="ATD*99***1#"/>	Dial AT Command	<input type="text" value="ATD*99***1#"/>

## VPN

In this section, we explain how to set up a VPN connection for the ioLogik 2500-GPRS/HSPA.

### Enable VPN

<input type="checkbox"/> Enable VPN			
VPN Tunnel Mode	Manual Key		
Remote Endpoint IP	. . .	Local Subnet IP	. . .
Remote Subnet IP	. . .	Local Subnet Netmask	255 . 255 . 255 . 0
Remote Subnet Netmask	255 . 255 . 255 . 0		

#### VPN Tunnel Mode

The type of VPN tunnel policy to be used; either manual key IPsec or ISAKMP with Pre-shared Keys (PSK).

#### Remote Endpoint IP

Enter the **WAN IP** of the remote VPN server endpoint.

#### Remote Subnet IP:

Enter the remote VPN server subnet (LAN) IP of the remote network.

#### Remote Subnet netmask

Enter the remote VPN server subnet netmask of the remote network.

#### Local subnet IP

Enter the ioLogik 2500's subnet (LAN) IP.

#### Local Subnet netmask

Enter the ioLogik 2500's subnet netmask.

## Manual Key

<b>Manual Key</b>			
<b>Incoming Security Settings</b>			
SPI	<input type="text"/>	Encryption Mode	DES
Encryption Key	<input type="text"/>	Authentication Mode	MD5
Authentication Key	<input type="text"/>		
<b>Outgoing Security Settings</b>			
SPI	<input type="text"/>	Encryption Mode	DES
Encryption Key	<input type="text"/>	Authentication Mode	MD5
Authentication Key	<input type="text"/>		

#### SPI

Set the VPN manual key for incoming/outgoing SPI between 257 and 4294967295.

#### Encryption mode

Select the incoming/outgoing encryption mode.

**Encryption key**

Enter the incoming/outgoing encryption key.

Encryption mode	Length (bytes)
DES	8
3DES	24
AES 128bit	16
AES 192bit	24
AES 256bit	32

**Authentication mode**

Select the incoming/outgoing authentication mode.

**Authentication key**

Enter the incoming/outgoing authentication key.

Authentication mode	Length (bytes)
MDS	16
SHA1	20

**ISAKMP/PSK**

**ISAKMP/PSK**

ISAKMP (Key Management)

Pre-Share Key (PSK)

Perfect Forward Secrecy (PFS)

Local Identify

Identity Option Default IP

IP/FQDN/User-FQDN

ISAKMP Phase 1

Operation Mode Main

NAT Traversal (NAT-T)

Encryption Mode DES

Authentication Mode MD5

Diffie-Hellman Group Group1-768 bits

SA Lifetime 86400 (600-86400 sec.)

ISAKMP Phase 2

Encryption Mode DES

Authentication Mode MD5

Diffie-Hellman Group Group1-768 bits

SA Lifetime 28800 (600-86400 sec.)

Advanced Settings

Anti-Replay  Dead Peer Detection (DPD)

**ISAKMP (Key Management)**

**Pre-shared key (PSK):** Sets the VPN ISAKMP Pre-Shared key settings.

**Perfect forward secrecy (PFS) (default = Disable):** Enable or disable the Perfect Forward Secrecy. PFS as an additional security protocol.

### **Local Identity**

**Identity option:** Select additional ID authentication requirements for the VPN using a specific IP Address, FQDN, or User FQDN settings.

**IP/FQDN/User\_FQDN:** Enter an ID (IP/FQDN/User\_FQDN) to identify and authenticate the local VPN endpoint.

### **ISAKMP phase 1**

**Operation mode:** Select main mode or aggressive mode to configure the standard negotiation parameters for IKE Phase 1 of the VPN Tunnel.

**NAT-T (default = Disable):** Enabling this option will allow IPSec traffic from this endpoint to traverse through the translation process during NAT. The remote VPN endpoint must also support this feature and it must be enabled to function properly over the VPN.

**Encryption mode:** Select the VPN ISAKMP phase 1 encryption mode. **Authentication mode:** Select the VPN ISAKMP phase 1 authentication mode. **Diffie-Hellman group:** Select the VPN ISAKMP phase 1 DH group. As the DH Group number increases, the higher the level of encryption implemented for PFS.

**SA life time (default = 86400):** Enter the number of seconds for the VPN ISAKMP phase 1 Lifetime. This is the period of time that passes before establishing a new IPSec security association (SA) with the remote endpoint.

### **ISAKMP phase 2**

**Encryption mode:** Select the VPN ISAKMP phase 2 encryption mode. **Authentication mode:** Select the VPN ISAKMP phase 2 authentication mode.

**Diffie-Hellman group:** Select the VPN ISAKMP phase 2 DH group. As the DH Group number increases, the higher the level of encryption implemented for PFS.

**SA life time (default = 28800):** Enter the number of seconds for the VPN ISAKMP phase 2 Lifetime. This is the period of time that passes before establishing a new IPSec security association (SA) with the remote endpoint.

### **Advanced settings**

**Anti-replay (default = Disable):** Anti-replay is the method of not allowing an intercepted packet message to be sent to the recipient multiple times without the original sender knowing about it.

**Dead Peer Detection (DPD) (default = Disable):** Enable or disable Dead Peer Detection. DPD is a method of detecting a dead Internet Key Exchange (IKE) peer. It sends a DPD packet to the peer every 60 seconds under no traffic and attempts to connect normally. If the DPD packet fails 5 times the VPN will continuously re-establish a connection.



## Reconnection

Carriers disconnect idle mobile device connections in order to save bandwidth for other on-line users and applications. To keep the ioLogik 2500-GPRS/HSPA always On, the ioLogik 2500-GPRS/HSPA must not only have the capability to detect the cellular connection and reconnect to the network once it is disconnected, but also needs to send out signals (ICMP package) to notify carriers that the ioLogik 2500-GPRS/HSPA is still alive.

**Dual SIM Failover Mode**  
(Note: if disabled, only SIM1 is activated when two SIMs are installed.)

**Reconnect cellular network after address**  ping failure for 3 times  
Ping Interval  sec(s) (10 to 600, default: 60)

**Restart device after reconnection failure for**  hour(s) (1 to 24, default: 1)

### Dual SIM Failover Mode

When the **Dual SIM Failover Mode** checkbox is selected, the ioLogik 2500-GPRS/HSPA will switch from one SIM card to the other when a connection cannot be established using the active SIM card.

If the function is disabled, only SIM1 is activated when two SIMs are installed.

### Reconnect cellular network after 3 ping failures

The device will keep pinging Dest.IP/URL after an Internet connection is established. If the ping fails three times, the ioLogik 2500-GPRS/HSPA will start the GSM reconnection process.

#### Dest IP/URL

Can either be an AOPC server IP or any public URL for the device to check its connection with the internet.

**NOTE** If using a URL, you may need to configure DNS through **Network → LAN → IP Settings**.

#### Ping Interval

The ioLogik 2500-GPRS/HSPA will ping the Dest IP/URL at regular intervals to check for an Internet connection.

### Restart device after reconnection fails for X hours (1 to 24)

If rebooting the **Reconnect cellular network after ping failure** does not reestablish your connection, the disconnection may be caused by a higher layer communication problem. In this case, you can select **Restart device after reconnection failure** for any time interval from 1 to 24 hours. The ioLogik 2500-GPRS/HSPA will restart the device.

## Port Forwarding

The ioLogik 2500-GPRS/HSPA supports port forwarding on its cellular and Ethernet interfaces for WAN-to-LAN communication. Using port forwarding, the ioLogik 2500-GPRS/HSPA allows external WAN hosts such as SCADA/HMI systems to connect to specific field devices within the LAN by linking with the ioLogik 2500-GPRS/HSPA.

Enable Port Forwarding

Enabled	Index	Protocol	Public Port	Internal IP	Internal Port
<input checked="" type="checkbox"/>	0	TCP	80	192.168.127.50	8000
<input type="checkbox"/>	1	TCP	2	0.0.0.2	2
<input type="checkbox"/>	2	TCP	3	0.0.0.3	3
<input type="checkbox"/>	3	TCP	4	0.0.0.4	4
<input type="checkbox"/>	4	TCP	5	0.0.0.5	5
<input type="checkbox"/>	5	TCP	6	0.0.0.6	6
<input type="checkbox"/>	6	TCP	7	0.0.0.7	7
<input type="checkbox"/>	7	TCP	8	0.0.0.8	8
<input type="checkbox"/>	8	TCP	9	0.0.0.9	9
<input type="checkbox"/>	9	TCP	10	0.0.0.10	10

Ethernet packages from public ports will be forwarded to the assigned Internal IP and Internal Port. In the example shown above, Ethernet packets from the ioLogik 2500's port 80 will be forwarded to 192.168.127.50:8000 (IP: 192.168.127.50; Port: 8000).

### **Enable Port Forwarding**

Enable or disable the port forwarding function.

### **Index**

The port forwarding rules index for identification, cannot be changed.

### **Protocol**

Choose which Ethernet protocol will be forwarded. You can choose either TCP or UDP.

### **Internal IP**

The destination IP that Ethernet packets will be forwarded to.

### **Internal Port**

The destination port that Ethernet packets will be forwarded to.

## DDNS

The purpose of DDNS is to provide you with an alternative cost effective cellular plan. You will not need to establish a server or pay for a Static IP. Setting up DDNS allows the ioLogik 2500-GPRS/HSPA to behave like a server and perform functions such as email, ftp, etc. Regardless of whether the device has a floating IP or a private IP, the user can establish a connection with their remote device through DDNS. DDNS allows the SCADA/HMI server to establish a connection through the DDNS server to find the remote device.

Enable DDNS

Service Provider: DynDns.org

Host Name:

Username:

Password:

### Service Provider (default=DynDns.org)

Currently, DynDns.org is the only option available for Server address.

#### Host name

Enter the name you created on www.dyndns.com in this field. The ioLogik 2500-GPRS/HSPA will update the DynDNS server with this host name.

#### Username

This is the user name used for updating DDNS Server authentication.

#### Password

This is the password used for updating DDNS Server authentication.

## Cellular Data Access

The **Cellular Data Access** setting is used for connecting to Moxa cellular data access utilities.

For detailed information on how to set up the cellular data access server, see the next section, **Moxa Cellular Data Access Utility**.

Enable Cellular Data Access

IP Address: 0 . 0 . 0 . 0

Port: 9401

Unique ID: 0

Heartbeat (sec.): 30

#### IP address

Enter the IP address of the cellular data access server.

#### Port

Enter the port number of the cellular data access server.

**Unique ID**

The unique ID is used for remote action functions. For detailed information, refer to the Click&Go Plus User's Manual.

**Heartbeat (sec.)**

The heartbeat is used to determine whether or not the connection between an ioLogik device and the cellular data access server is still active.

## Cellular Network Connection

The dynamic IP addresses commonly used for cellular connections make it hard for control systems to link to cellular data acquisition devices. With Moxa's MX-AOPC server, SCADA/HMI users can easily connect to field I/O devices. For web-based applications, Moxa's cellular data access utility provides an ideal way to seamlessly connect to remote cellular IO units.

### MX-AOPC Server (for SCADA/HMI users)

To allow private networks to get around the connectivity issues raised by edge devices configured with dynamically assigned private IP addresses, typically operators purchase high-cost static IP addresses for each device, with IPs provided by a DDNS or VPN service purchased from an MVNO (Mobile Virtual Network Operator). Even with DDNS technology, SCADA systems need to assign resources to manage the DDNS servers. As an alternative, Moxa's Cellular remote I/O devices use Moxa's proprietary "push" technology, called MX-AOPC Server.

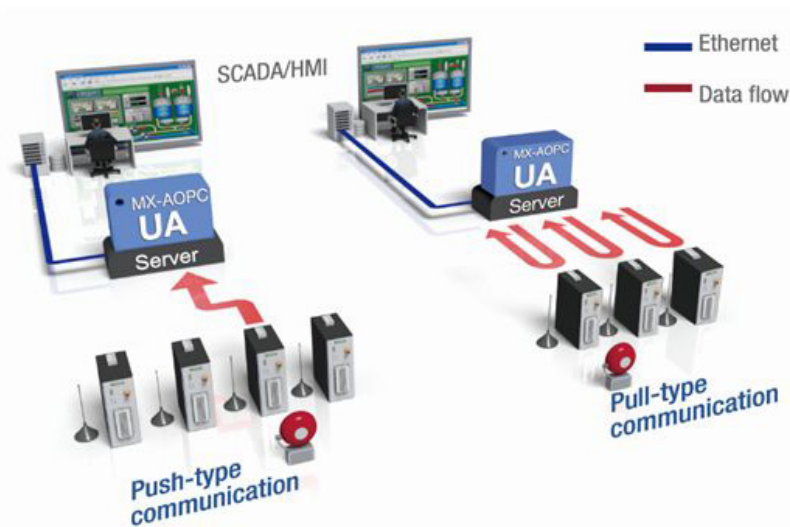

With Moxa's powerful MX-AOPC Server support, communications efficiency between ioLogik 2500-GPRS/HSPA devices and the central SCADA are substantially improved. Moxa's MX-AOPC Server's non-polling communications architecture supports the standard OPC protocol, but instead of requiring the SCADA to poll edge devices it allows edge devices to actively push communications to the central HMI/SCADA system, empowering the network with real time I/O updates while substantially cutting network overhead.

Unlike the requirements of a traditional OPC server (where remote I/O devices must use a static IP so they may be successfully polled), MX-AOPC Server and ioLogik products allow engineers the flexibility of configuring edge devices with dynamic IP addresses. Even when using DHCP addressing, ioLogik devices can push messages back to the OPC server, allowing wide area I/O networks using dynamic IP cellular accounts. Using traditional polling OPC applications, I/O devices cannot make use of this approach.

## With DDNS (for SCADA/HMI users)

In addition to using MX-AOPC Server to register an ioLogik ioLogik 2500-GPRS/HSPA with SCADA over a dynamic IP cellular connection, you may also use DDNS to configure the device with a unique URL. The ioLogik 2500-GPRS/HSPA can be configured to register a DNS hostname (i.e. – URL) with DDNS, and thereby convert a dynamic IP to a publicized address. In this way, centralized control software will be able to connect to the remote ioLogik W5300 without requiring a fixed IP or VPN service from a network provider.

## Moxa Cellular Data Access Utility (for mobile devices/PCs)

With the Moxa cellular data access utility, you can configure the ioLogik 2500-GPRS/HSPA using the IOxpress utility over the cellular network. You can also log on to selected ioLogik 2500 devices by using a specific URL port. In this section, we explain how to use these two methods to connect devices.

### Step1: Installing Cellular Data Access Utility on a server PC

**Cellular Data Access Utility** is a Windows utility provided for connecting and managing the ioLogik 2500-GPRS/HSPA over a cellular network. Cellular Data Access Utility can be used from anywhere on the network to monitor and configure the ioLogik 2500-GPRS/HSPA.

#### Downloading from Moxa's Website

Click the following link: <http://www.moxa.com/support/search.aspx?type=soft>.

Enter the name of the product you have purchased into the search bar or select it from the dropdown menu, and after navigating to the product page click on Utilities, in the middle of the page, located in the box titled Software.

Download and then unzip the file, and then run **SETUP.EXE** from that location.

The installation program will guide you through the installation process and install the software. After the installation is finished, run the software from the Windows Start menu.

### Step2: Use “offline configuration” to set up the ioLogik 2500-GPRS/HSPA

Before you start using the cellular data access utility, set up the “cellular data access” function. See the **Cellular Data Access** section in this chapter for details.

## Step3: Connect to the device over the cellular network

### Using IOxpress

Connect to the cellular Data Access server using Online Device Management, as described below:

1. Click **Online Device Management**.
2. Select **Add Device by Cellular Data Access**.

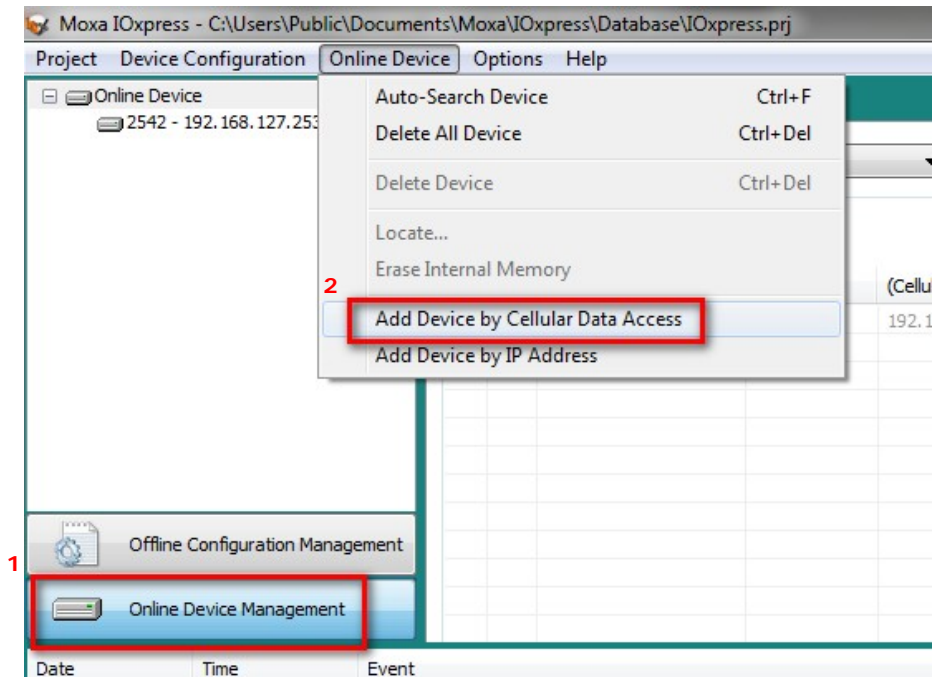

3. Type in the server's IP address and port number.
4. Click the **Connect** checkbox.
5. Select the cellular device that you would like to connect to.

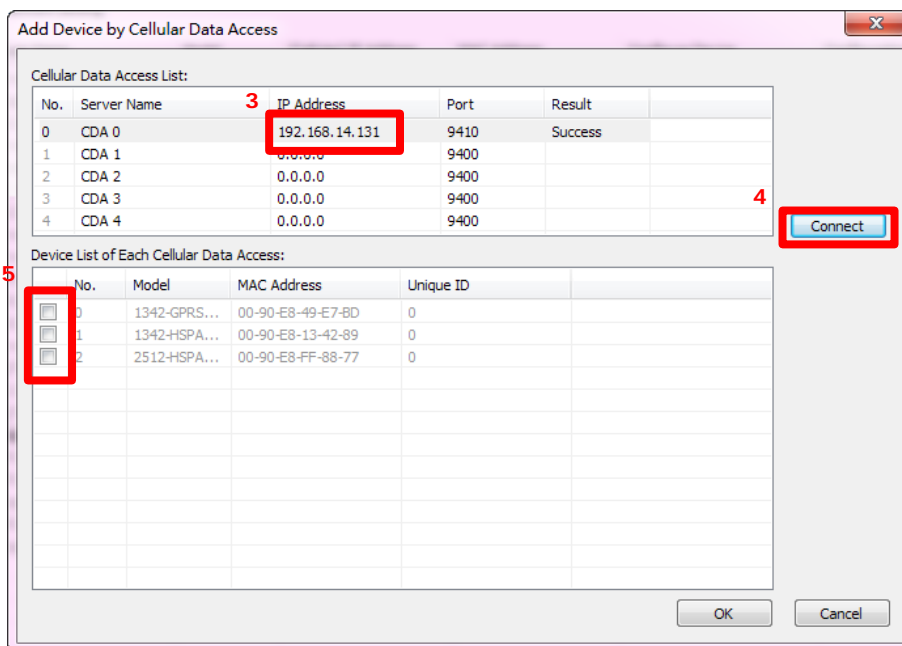

6. The selected devices have been added to the online device list, and you can start to upload/configure your devices over the cellular network.

## Using a browser URL

1. Check the port number in the cellular data access utility.

Once the devices are connected, the utility will automatically assign URL ports to the devices.

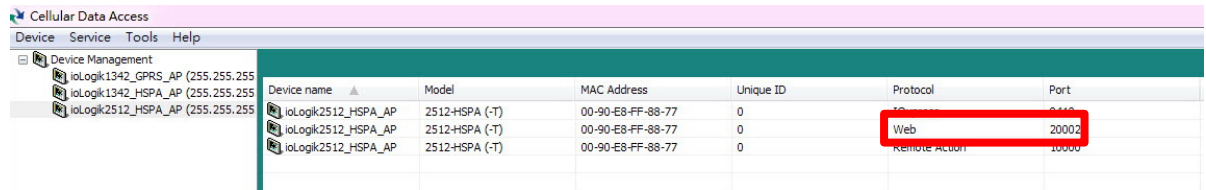

Device name	Model	MAC Address	Unique ID	Protocol	Port
ioLogik2512_HSPA_AP	2512-HSPA (-T)	00-90-E8-FF-88-77	0	Web	20002
ioLogik2512_HSPA_AP	2512-HSPA (-T)	00-90-E8-FF-88-77	0	Remote Action	10000

2. Access the device via the browser.

You can use the URL to connect to the device by typing **http://[IP address] : [Port]**.

IP Address: The IP address of the Cellular Data Access server.

Port: The port number of the device assigned by Cellular Data Access.

E.g., 192.168.17.253:20002

# Wireless LAN Network Setup and Configuration (for wireless LAN models)

---

In this chapter, we introduce how to set up your ioLogik 2500-WL1 device.

The following topics are covered in this chapter:

- ❑ **Deploying the ioLogik 2500-WL1**
- ❑ **IOxpress Settings for a Wireless LAN Network**
  - Wireless LAN



## Deploying the ioLogik 2500-WL1

For testing requirements, we strongly suggest that you prepare a wireless LAN adapter. After finishing the installation and configuration, you should test the ioLogik 2500-WL1 to make sure the wireless transmission is working normally.

**Step 1: Set up the computer's IP address, and the connect ioLogik 2500-WL1 to a notebook or PC.**

In a Windows environment, the computer's IP address can be changed in the TCP/IP settings window. Select an IP address on the same subnet as the ioLogik 2500-WL1. Since the ioLogik 2500-WL1's default IP address is 192.168.127.253, and the subnet mask is 255.255.255.0, you should set the IP address of the computer to 192.168.127.xxx.

**Step 2: Use the IOxpress utility to configure the ioLogik 2500-WL1.**

See the following section to learn how to use IOxpress to configure the ioLogik 2500-WL1's functions.



### ATTENTION

Be sure to eliminate loops from networks that consist of wireless bridges, Ethernet switches, Ethernet links, and Wireless LAN links. If any loops exist, packets will circle around the loops and network performance will be seriously degraded. The following figure shows a network topology containing a loop.

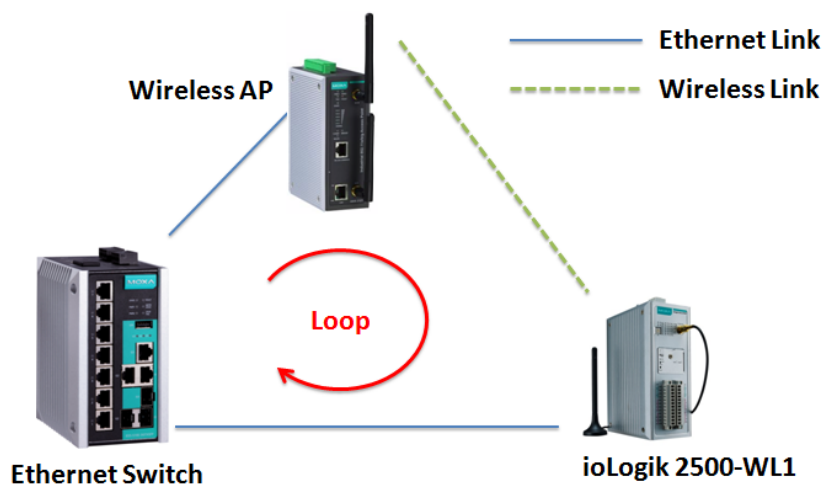

## IOxpress Settings for a Wireless LAN Network

When you add an ioLogik 2500-WL1 model to your network, the following two functions will be available (in addition to the functions discussed in Chapter 3).

### Wireless LAN

Cellular network settings are configured on the "cellular" page, which is located under "Network."

#### Basic

The Basic tab is used to add and edit RF type, channel width, and SSID.

**RF Type**

***SSID***

Setting	Description	Factory Default
B	Supports IEEE 802.11b only	B/G Mixed
G	Supports IEEE 802.11g only	
B/G Mixed	Supports both IEEE 802.11b/g standards, but 802.11g will operate more slowly when 802.11b clients are on the network	
A Only	Supports IEEE 802.11a only	

**Channel Width**

***Channel Width***

Setting	Description	Factory Default
20 MHz	Select your channel width. If you are not sure which option to use, select 20/40 MHz (Auto)	20 MHz
20/40 MHz		

**SSID**

An SSID is a unique identifier that wireless networking devices use to establish and maintain wireless connectivity. Multiple access points on a network or sub-network can use the same SSIDs.

***SSID***

Setting	Description	Factory Default
Max. of 31 characters	The SSID of a client and the SSID of the AP must be identical for the client and AP to be able to communicate with each other.	MOXA

**NOTE** The model name of the ioLogik 2500-WL1 is shown as ioLogik 2500-WL-XX in IOxpress, where XX indicates the country code. The country code indicates the ioLogik 2500-WL1 version and which bandwidth it uses. We use ioLogik 2500-WL1-US as an example in the following figures. (The country code and model name that appear on your computer screen may be different than the ones shown here.)

## Security

The ioLogik 2500-WL1 provides four standardized wireless security modes: Open, WEP (Wired Equivalent Privacy), WPA (Wi-Fi Protected Access), and WPA2.

### Security Mode

**Open**

No authentication, no data encryption.

For security reasons, users should NOT set the security mode to Open System, since authentication and data encryption are NOT performed in Open System mode.

**WEP**

Static WEP (Wired Equivalent Privacy) keys must be configured manually.

According to the IEEE 802.11 standard, WEP can be used for authentication and data encryption to maintain confidentiality. **Shared** (or **Shared Key**) authentication type is used if WEP authentication and data encryption are both needed. Normally, **Open** (or **Open System**) authentication type is used when WEP data encryption is run with authentication.

When WEP is enabled as a security mode, the length of a key (the so-called WEP seed) can be specified as 64/128 bits, which is actually a 40/104-bit secret key with a 24-bit initialization vector. The ioLogik 2500-WL1 provides 4 entities of WEP key settings that can be selected to use with **Key index**. The selected key setting specifies the key to be used as a send-key for encrypting traffic from the AP side to the wireless client side. All 4 WEP keys are used as receive-keys to decrypt traffic from the wireless client side to the AP side.

The WEP key can be presented in two **Key types**, HEX and ASCII. Each ASCII character has 8 bits, so a 64-bit WEP key contains 8 characters, and a 128-bit key has 16 characters. In hex, each character uses 4 bits, so a 64-bit key has 16 hex characters, and a 128-bit key has 32 characters.

**Authentication type**

Setting	Description	Factory Default
Open	Data encryption is enabled, but without authentication	Open
Shared	Data encryption and authentication are both enabled.	

**Key type**

Setting	Description	Factory Default
HEX	Specifies WEP keys in hex-decimal number format	HEX
ASCII	Specifies WEP keys in ASCII format	

**Key length**

Setting	Description	Factory Default
64 bits	Uses 40-bit secret keys with 24-bit initialization vector	64 bits
128 bits	Uses 104-bit secret key with 24-bit initialization vector	

**Key index**

Setting	Description	Factory Default
1-4	Specifies which WEP key is used	Open

**WEP key 1-4**

Setting	Description	Factory Default
	A string that can be used as a WEP seed for the RC4 encryption engine.  ASCII type: 64 bits: 5 chars / 128 bits: 13chars HEX type: 64 bits: 10 hex chars / 128 bits: 26 hex chars	None

**WPA/WPA2-Personal**

Also known as WPA/WPA2-PSK. You will need to specify the Pre-Shared Key in the Passphrase field, which will be used by the TKIP or AES engine as a master key to generate keys that actually encrypt outgoing packets and decrypt incoming packets.

WPA (Wi-Fi Protected Access) and WPA2 represent significant improvements over the WEP encryption method. WPA is a security standard based on 802.11i draft 3, while WPA2 is based on the fully ratified version of 802.11i. The initial vector is transmitted, encrypted, and enhanced with its 48 bits, twice as long as WEP. The key is regularly changed so that true session is secured.

Even though AES encryption is only included in the WPA2 standard, it is widely available in the WPA security mode of some wireless APs and clients as well. The ioLogik 2500-WL1 also supports AES algorithms in WPA and WPA2 for better compatibility.

Personal versions of WPA/WPA2, also known as WPA/WPA-PSK (Pre-Shared Key), provide a simple way of encrypting a wireless connection for high confidentiality. A **Passphrase** is used as a basis for encryption methods (or cipher types) in a WLAN connection. The passphrases should be complicated and as long as possible. The Passphrase must have at least 8 ASCII characters, and can have as many as 63. For security reasons, this passphrase should only be disclosed to users who need it, and it should be changed regularly.

**WPA/WPA2-Enterprise**

*WPA type*

Setting	Description	Factory Default
Personal	Provides Pre-Shared Key-enabled WPA and WPA2	Personal
Enterprise	Provides enterprise-level security for WPA and WPA2	

*Encryption method*

Setting	Description	Factory Default
TKIP	Temporal Key Integrity Protocol is enabled	TKIP
AES	Advanced Encryption System is enabled	

*Passphrase*

Setting	Description	Factory Default
8 to 63 characters	Master key to generate keys for encryption and decryption	None

*EAP Protocol*

Setting	Description	Factory Default
TLS	Specifies Transport Layer Security protocol	TLS
TTLS	Specifies Tunneled Transport Layer Security	
PEAP	Specifies Protected Extensible Authentication Protocol, or Protected EAP	

**WPA/WPA2-Enterprise**

Also called WPA/WPA2-EAP (Extensible Authentication Protocol). In addition to device-based authentication, WPA/WPA2-Enterprise enables user-based authentication via IEEE 802.1X. The ioLogik 2500-WL1 can support three EAP methods: EAP-TLS, EAP-TTLS, and EAP-PEAP.

By setting **WPA type** to **Enterprise**, you can use EAP (Extensible Authentication Protocol), a framework authentication protocol used by 802.1X to provide network authentication. In these Enterprise-level security modes, a back-end RADIUS (Remote Authentication Dial-In User Service) server is needed if IEEE 802.1X functionality is enabled in WPA /WPA2. The IEEE 802.1X protocol also offers the possibility of carrying out an efficient connection authentication on a large-scale network. It is not necessary to exchange keys or passphrases.

*WPA type*

Setting	Description	Factory Default
Personal	Provides Pre-Shared Key-enabled WPA and WPA2	Personal
Enterprise	Provides enterprise-level security for WPA and WPA2	

*Encryption method*

Setting	Description	Factory Default
TKIP	Temporal Key Integrity Protocol is enabled	TKIP
AES	Advanced Encryption System is enabled	

*Passphrase*

Setting	Description	Factory Default
8 to 63 characters	Master key to generate keys for encryption and decryption	None

**EAP-TLS**

TLS is the standards-based successor to Secure Socket Layer (SSL). It can establish a trusted communication channel over a distrusted network. TLS provides mutual authentication through certificate exchange. EAP-TLS is also secure to use. You are required to submit a digital certificate to the authentication server for validation, but the authentication server must also supply a certificate.

**EAP Protocol**

Setting	Description	Factory Default
TLS	Specifies Transport Layer Security protocol	TLS
TTLS	Specifies Tunneled Transport Layer Security	
PEAP	Specifies Protected Extensible Authentication Protocol, or Protected EAP	

**EAP-TTLS**

It is usually much easier to re-use existing authentication systems, such as a Windows domain or Active Directory, LDAP directory, or Kerberos realm, rather than creating a parallel authentication system. As a result, TTLS (Tunneled TLS) and PEAP (Protected EAP) are used to support the use of so-called “legacy authentication methods.” TTLS and PEAP work in a similar way. First, they establish a TLS tunnel (EAP-TLS for example), and validate whether the network is trustworthy with digital certificates on the authentication server. This step establishes a tunnel that protects the next step (or “inner” authentication), and consequently is sometimes referred to as “outer” authentication. The TLS tunnel is then used to encrypt an older authentication protocol that authenticates the user for the network.

As you can see, digital certificates are still needed for outer authentication in a simplified form. Only a small number of certificates are required, which can be generated by a small certificate authority. Certificate reduction makes TTLS and PEAP much more popular than EAP-TLS.

The ioLogik 2500-WL1 provides some non-cryptographic EAP methods, including **PAP**, **CHAP**, **MS-CHAP**, and **MS-CHAP-V2**. These EAP methods are not recommended for direct use on wireless networks. However, they may be useful as inner authentication methods with TTLS and PEAP.

Because the inner and outer authentications can use distinct user names in TTLS and PEAP, you can use an anonymous user name for the outer authentication, with the true user name only shown through the encrypted channel. Keep in mind that not all client software supports anonymous alteration. Confirm this with the network administrator before you enable identity hiding in TTLS and PEAP.

**TTL Inner Authentication**

Setting	Description	Factory Default
PAP	Password Authentication Protocol is used	MS-CHAP-V2
CHAP	Challenge Handshake Authentication Protocol is used	
MS-CHAP	Microsoft CHAP is used	
MS-CHAP-V2	Microsoft CHAP version 2 is used	

**Anonymous**

Setting	Description	Factory Default
Max. of 31 characters	A distinct name used for outer authentication	None

**User name & Password**

Setting	Description	Factory Default
	User name and password used in inner authentication	None

**PEAP**

There are a few differences in the TTLS and PEAP inner authentication procedures. TTLS uses the encrypted channel to exchange attribute-value pairs (AVPs), while PEAP uses the encrypted channel to start a second EAP exchange inside of the tunnel. The ioLogik 2500-WL1 provides **MS-CHAP-V2** merely as an EAP method for inner authentication.

**Inner EAP protocol**

Setting	Description	Factory Default
MS-CHAP-V2	Microsoft CHAP version 2 is used	MS-CHAP-V2

**Anonymous**

Setting	Description	Factory Default
Max. of 31 characters	A distinct name used for outer authentication	None

**User name & Password**

Setting	Description	Factory Default
	User name and password used in inner authentication	None

## Advanced

Additional wireless-related parameters are presented in this section to help you set up your wireless network in detail.

**Advanced Settings**

**Transmission Rate**

Setting	Description	Factory Default
Auto	The device senses and adjusts the data rate automatically	Auto

**Transmission Power**

Setting	Description	Factory Default
3 dBm to 20 dBm	The device adjusts the transmission power	10 dBm

**Fragmentation threshold**

Setting	Description	Factory Default
256 to 2346	Specifies the maximum size of a data packet before splitting and creating another new packet	2346

**RTSreshold**

Setting	Description	Factory Default
256 to 2346	Determines how large a packet can be before the Access Point coordinates transmission and reception to ensure efficient communication	2346

**WMM**

Setting	Description	Factory Default
Enable/ Disable	WMM is a QoS standard for WLAN traffic. Voice and video data will be given priority bandwidth when enabled with WMM supported wireless clients.	Enable

**Turbo Roaming**

Setting	Description	Factory Default
Enable/ Disable	Moxa's Turbo Roaming can enable rapid handover when the device, as a client, roams among a group of APs.	Disable

***AP Alive Check***

AP alive check will check if the AP connection is still available. When this function is enabled, a check will be done every 10 ms.

***AP Candidate Threshold***

After the "AP alive check" declares the current access point is no longer available, the surrounding access points must have good enough connection qualities (SNR/Signal Strength) in order to be qualified as AP candidates for association.

***Roaming Threshold***

Determines when to start looking for new AP candidates. If the current connection quality (SNR or Signal Strength) is lower than the specified threshold, the ioLogik will start background scanning and look for next-hop candidates.

***Roaming Difference***

Determines if roaming should be executed. After a background scan has been triggered, the roaming will only occur if the AP candidate(s) provide a better (Roaming difference) connection quality than the current connection. If multiple access points fulfill the criteria, the ioLogik will pick the best one to roam to.

***Scan Channels***

You can set up Scan channels for the APs among which this client is going to roam. There are three Scan channels available.

Note that the Scan channels may need to be modified when the RF type is changed. (For example, channel 36 is not available in B, G, or B/G Mix mode.)

## Network Port Usage

---

The ioLogik 2500 uses the following network ports:

Usage	Type	Port	User-Defined
Serial Tunnel Client	TCP	1	✓
FTP Client	TCP	21	✓
FTP Server	TCP	21	
Web Console	TCP	80	
SNMP Server	TCP	161	
SNMP Client	TCP	162	
Modbus Communication	TCP	502	
SMTP	TCP	587	✓
Serial Tunnel Server	TCP	4001	✓
Auto Search Function	UDP	4800	
TCP/UDP Message	TCP	9000	✓
	UDP	9000	✓
Remote Action Function	TCP	9010	
Peer-to-peer Function	TCP	9300	✓
IOxpress	TCP	10124	
AOPC Protocol*	TCP	9500	
	TCP	9900	✓

\*The ioLogik 2500 series only supports MX-AOPC UA server.

- NOTE**
- Client refers to when the ioLogik 2500 is acting as a client to connect other services.
  - Server refers to when the ioLogik 2500 is acting as a server to provide services to other devices.