

DrayTek

Vigor2762 Series

ADSL2/2+ & VDSL2 Router



Quick Start Guide (RF Model)

V1.3

Vigor2762 Series ADSL2/2+ & VDSL2 Router Quick Start Guide (RF Model)

Version: 1.3

Firmware Version: V3.9.2

(For future update, please visit DrayTek web site)

Date: January 9, 2020

Intellectual Property Rights (IPR) Information

Copyrights

© All rights reserved. This publication contains information that is protected by copyright. No part may be reproduced, transmitted, transcribed, stored in a retrieval system, or translated into any language without written permission from the copyright holders.

Trademarks

The following trademarks are used in this document:

- Microsoft is a registered trademark of Microsoft Corp.
- Windows, Windows 95, 98, Me, NT, 2000, XP, Vista, 7, 8 and Explorer are trademarks of Microsoft Corp.
- Apple and Mac OS are registered trademarks of Apple Inc.
- Other products may be trademarks or registered trademarks of their respective manufacturers.

Safety Instructions and Approval

Safety Instructions

- Read the installation guide thoroughly before you set up the router.
- The router is a complicated electronic unit that may be repaired only by authorized and qualified personnel. Do not try to open or repair the router yourself.
- Do not place the router in a damp or humid place, e.g. a bathroom.
- Do not stack the routers.
- The router should be used in a sheltered area, within a temperature range of 0 to +40 Celsius.
- Do not expose the router to direct sunlight or other heat sources. The housing and electronic components may be damaged by direct sunlight or heat sources.
- Do not deploy the cable for LAN connection outdoor to prevent electronic shock hazards.
- Keep the package out of reach of children.
- When you want to dispose of the router, please follow local regulations on conservation of the environment.

Warranty

We warrant to the original end user (purchaser) that the router will be free from any defects in workmanship or materials for a period of two (2) years from the date of purchase from the dealer. Please keep your purchase receipt in a safe place as it serves as proof of date of purchase. During the warranty period, and upon proof of purchase, should the product have indications of failure due to faulty workmanship and/or materials, we will, at our discretion, repair or replace the defective products or components, without charge for either parts or labor, to whatever extent we deem necessary to restore the product to proper operating condition. Any replacement will consist of a new or re-manufactured functionally equivalent product of equal value, and will be offered solely at our discretion. This warranty will not apply if the product is modified, misused, tampered with, damaged by an act of God, or subjected to abnormal working conditions. The warranty does not cover the bundled or licensed software of other vendors. Defects which do not significantly affect the usability of the product will not be covered by the warranty. We reserve the right to revise the manual and online documentation and to make changes from time to time in the contents hereof without obligation to notify any person of such revision or changes.



Declaration of Conformity

Hereby, DrayTek Corporation declares that the radio equipment type Vigor2762 is in compliance with Directive 2014/53/EU.

The full text of the EU declaration of conformity is available at the following internet address:

<http://www.draytek.com.tw/ftp/Vigor2762/Document/CE/>

Manufacturer: DrayTek Corp.

Address: No. 26, Fu Shing Road, HuKou Township, HsinChu Industrial Park, Hsin-Chu County, Taiwan 303

Product: Vigor2762 Series

Frequency Information for Europe area:

| | |
|---|--|
| 2.4G WLAN | 2412MHz - 2472 MHz, max. TX power: 19.98dBm *1 |
| 5G WLAN | 5180MHz - 5700 MHz, max. TX power: 27.00dBm *2 |
|  | Requirements in AT/BE/BG/CZ/DZ/DK/EE/FR/DE/IS/IE/IT/EL/ES/CY/LV/LI/LT/LU/HU/MT/NL/NO/PL/PT/RO/SI/SK/TR/FI/SE/CH/UK/HR. 5150MHz~5350MHz is for indoor use only. |

(*1: for 2.4G WLAN model; *2: for 5G WLAN model)

This product is designed for DSL, POTS and 2.4GHz /5GHz WLAN network throughout the EC region.



Regulatory Information

Federal Communication Commission Interference Statement

This equipment has been tested and found to comply with the limits for a Class B digital device, pursuant to Part 15 of the FCC Rules. These limits are designed to provide reasonable protection against harmful interference in a residential installation. This equipment generates, uses and can radiate radio frequency energy and, if not installed and used in accordance with the instructions, may cause harmful interference to radio communications. However, there is no guarantee that interference will not occur in a particular installation. If this equipment does cause harmful interference to radio or television reception, which can be determined by turning the equipment off and on, the user is encouraged to try to correct the interference by one of the following measures:

- Reorient or relocate the receiving antenna.
- Increase the separation between the equipment and receiver.
- Connect the equipment into an outlet on a circuit different from that to which the receiver is connected.
- Consult the dealer or an experienced radio/TV technician for help.

This device complies with Part 15 of the FCC Rules. Operation is subject to the following two conditions:

- (1) This device may not cause harmful interference, and
- (2) This device may accept any interference received, including interference that may cause undesired operation.

RF Exposure Warning

This equipment must be installed and operated in accordance with provided instructions and the antenna(s) used for this transmitter must be installed to provide a separation distance of at least 20 cm from all persons and must not be co-located or operating in conjunction with any other antenna or

transmitter. End-users and installers must be provided with antenna installation instructions and transmitter operating conditions for satisfying RF exposure compliance.

Caution

Any changes or modifications not expressly approved by the grantee of this device could void the user's authority to operate the equipment.

The antenna/transmitter should be kept at least 20 cm away from human body.



More update, please visit www.draytek.com.

Table of Contents

| | |
|--|-----------|
| 1. Introduction..... | 1 |
| 2. Package Content | 2 |
| 3. Panel Explanation..... | 3 |
| 4. Hardware Installation | 5 |
| 4.1 Network Connection | 5 |
| 4.2 Wall-Mounted Installation | 6 |
| 5. Software Configuration | 7 |
| 6. Customer Service | 13 |
| Be a Registered Owner | 13 |
| Firmware & Tools Updates | 13 |

1. Introduction

The Vigor2762 series are the routers with high speed in data transmission through DSL port and LAN ports.

DrayTek launches Vigor2762 series - high speed router, perfectly complied with VDSL2 environment including Vigor2762n (2.4GHz), Vigor2762ac (2.4GHz/5GHz) and Vigor2762Vac (2.4GHz/5GHz with VoIP feature) for speed-wanted customers. With high throughput performance and secured broadband connectivity provided by Vigor2762 series, you can simultaneously engage these bandwidth-intensive applications, such as high-definition video streaming, online gaming, and Internet telephony / access.

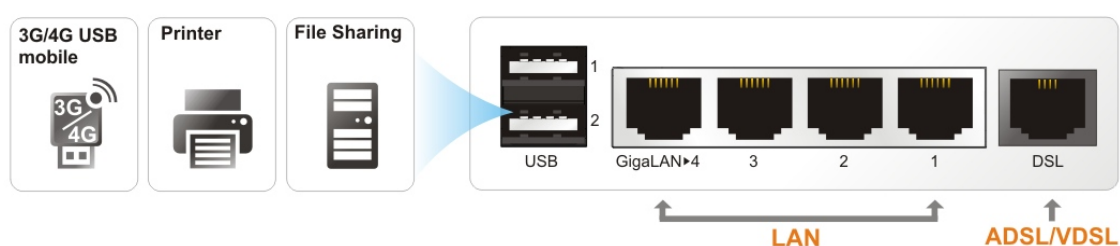

Vigor2762 supports VPN tunnel(s) using advanced protocols such as IPSec/PPTP (for remote dial-in only) with AES/3DES for encryption and MD5/SHA-1 for authentication.

Through the central management for multiple access points, Vigor router can set wireless profile in advance and apply to the access point managed easily and conveniently.

In addition, Vigor2762 series supports two USB interfaces for connecting USB printer to share the printer or USB storage device for sharing files and 3G/4G backup services.

2. Package Content

Take a look at the package content. If there is anything missed or damaged, please contact DrayTek or dealer immediately.



Vigor router

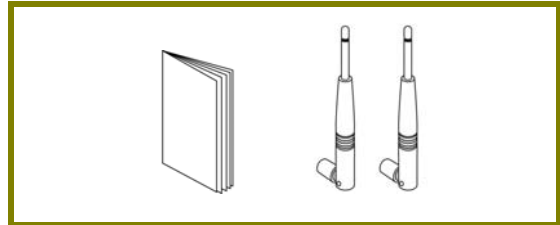

Quick Start Guide, Antenna (for “n” or “ac” model)

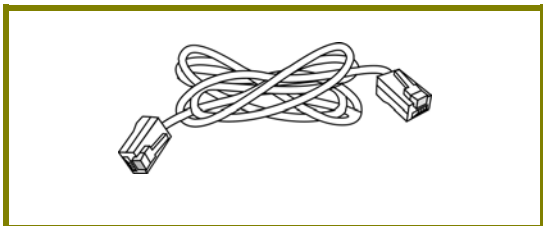

RJ-45 Cable (Ethernet)

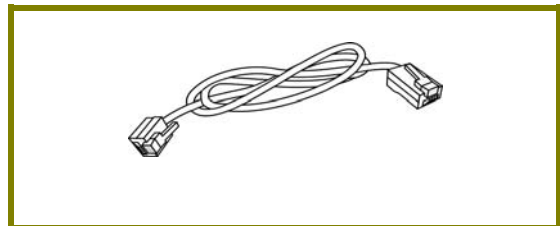

RJ-11 to RJ-11 Cable (Annex A)

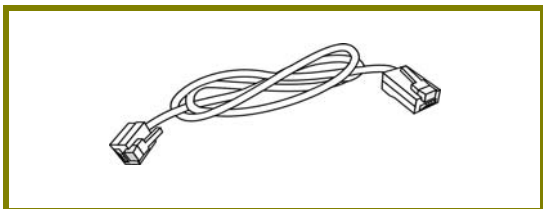

RJ-11 to RJ-45 Cable (Annex B)

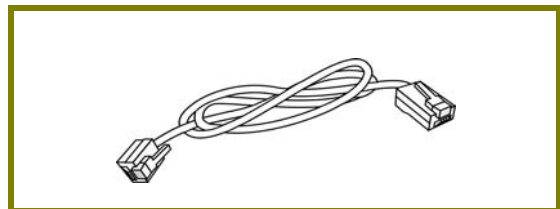

RJ-45 to RJ-45 Cable (Annex B)

The type of the power adapter depends on the country that the router will be installed. * The maximum power consumption is *17-23 Watt*.

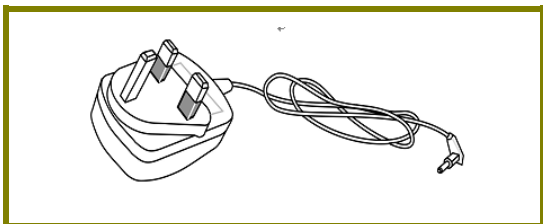

UK-type Power Adapter

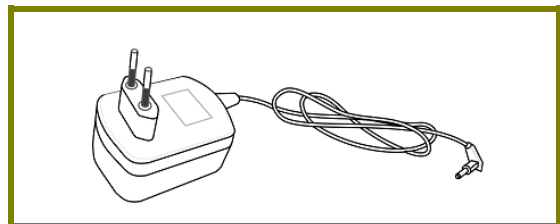

EU-type Power Adapter

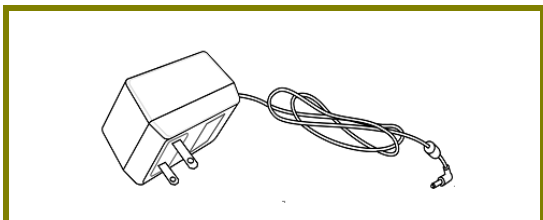



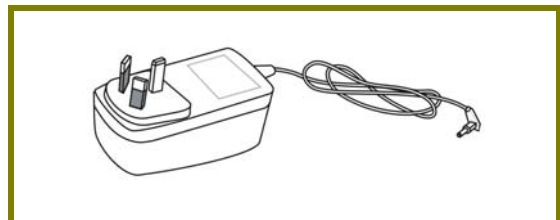



USA/Taiwan-type Power Adapter



AU/NZ-type Power Adapter

3. Panel Explanation



| LED | Status | Explanation |
|--|--------------------|---|
|  (Activity) | Blinking | The router is powered on and running normally. |
| | Off | The router is powered off. |
|  (for "V" model) | On | The phone connected to this port is off-hook. |
| | Off | The phone connected to this port is on-hook. |
| | Blinking | A phone call comes. |
|  (Wireless LAN On/Off/WPS) | On (Green) | The wireless access point is ready. |
| | Blinking (Green) | The data is transmitting via wireless connection based on the rate of 2.4GHz. |
| | Blinking (Orange) | Blinks with one second cycle for two minutes. The WPS function is active. |
| | Off | The wireless access point is turned off. |
|  (Wireless LAN On/Off/WPS) | On (Green) | The wireless access point is ready. |
| | Blinking (Green) | The data is transmitting via wireless connection based on the rate of 5GHz. |
| | Blinking (Orange) | Blinks with one second cycle for two minutes. The WPS function is active. |
|  (USB) | On | A USB device is connected and active. |
| | Blinking | The data is transmitting. |
|  (DSL) | On | The DSL port is connected. |
| | Blinking (Slowly) | The router is ready. |
| | Blinking (Quickly) | The router is trying to connect to Internet. |
|  | On | The LAN port is connected. |
| | Blinking | The data is transmitting. |
| | Off | The LAN port is disconnected. |

(LAN1/2/3/4)

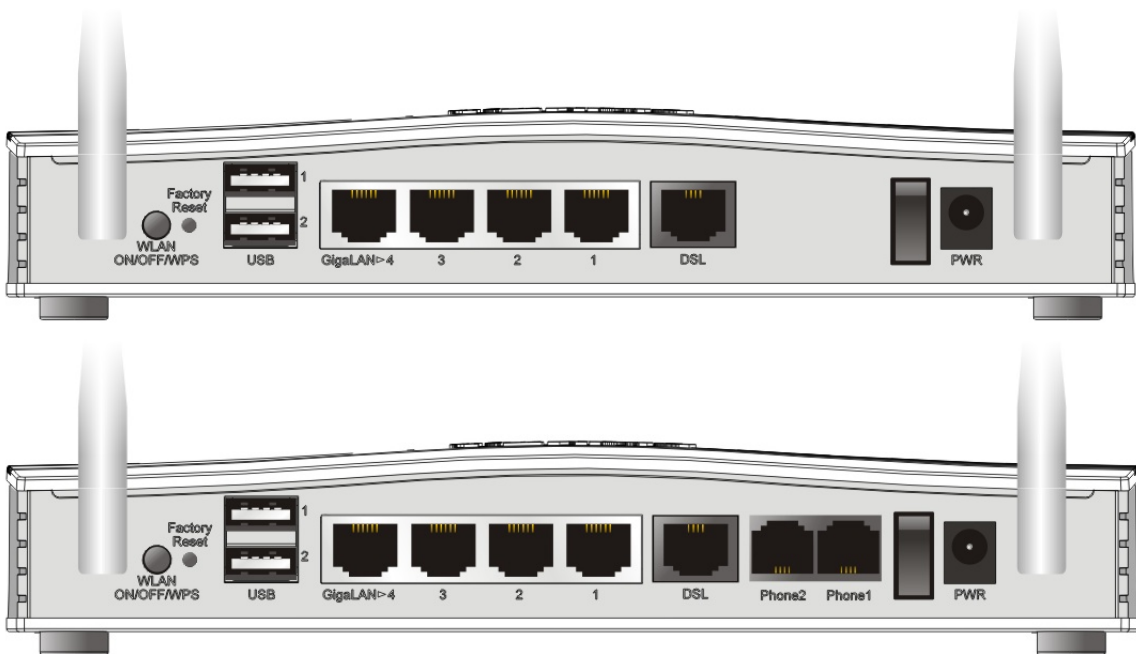

| Interface | Description |
|-------------------------------|---|
| WLAN ON/OFF/WPS | <p>WLAN On - Press the button and release it within 2 seconds. When the wireless function is ready, the green LED will be on.</p> <p>WLAN Off - Press the button and release it within 2 seconds to turn off the WLAN function. When the wireless function is not ready, the LED will be off.</p> <p>WPS - When WPS function is enabled by web user interface, press this button for more than 2 seconds to wait for client's device making network connection through WPS.</p> |
| Factory Reset | <p>Restore the default settings.</p> <p>Usage: Turn on the router (ACT LED is blinking). Press the hole and keep for more than 5 seconds. When you see the ACT LED begins to blink rapidly than usual, release the button. Then the router will restart with the factory default configuration.</p> |
| USB1~USB2 | Connector for a USB device (for 3G/4G USB Modem or printer). |
| GigaLAN1~LAN4 | Connectors for local networked devices. |
| DSL | Connector for accessing the Internet. |
| Phone2/Phone1 (for "V" model) | Connector of analog phone for VoIP communication. |
| I / O | Power Switch. |
| PWR | Connector for a power adapter. |

4. Hardware Installation

This section will guide you to install the router through hardware connection and configure the router's settings through web browser.

Before starting to configure the router, you have to connect your devices correctly.

4.1 Network Connection

1. Connect the DSL interface to the land line jack with a DSL line cable.
2. Connect one port of 4-port switch to your computer with a RJ-45 cable. This device allows you to connect 4 PCs directly.
3. Connect detachable antennas to the router.
4. Connect one end of the power cord to the power port of this device. Connect the other end to the wall outlet of electricity.
5. Power on the router.
6. Check the ACT and DSL, LAN LEDs to assure network connection.

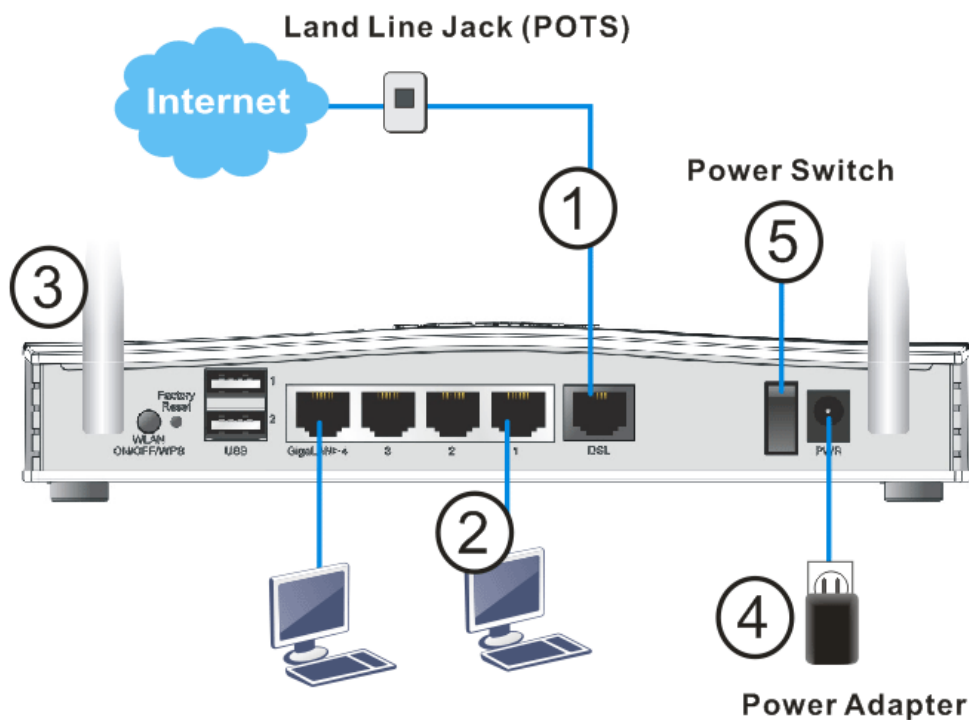

(For the detailed information of LED status, please refer to section 1.1.)



Note

Remove the protective film from the router before use to ensure ventilation.

4.2 Wall-Mounted Installation

Vigor2762 wireless series has keyhole type mounting slots on the underside.

1. A template is provided on the Vigor2762 packaging box to enable you to space the screws correctly on the wall.
2. Place the template on the wall and drill the holes according to the recommended instruction.
3. Fit screws into the wall using the appropriate type of wall plug.

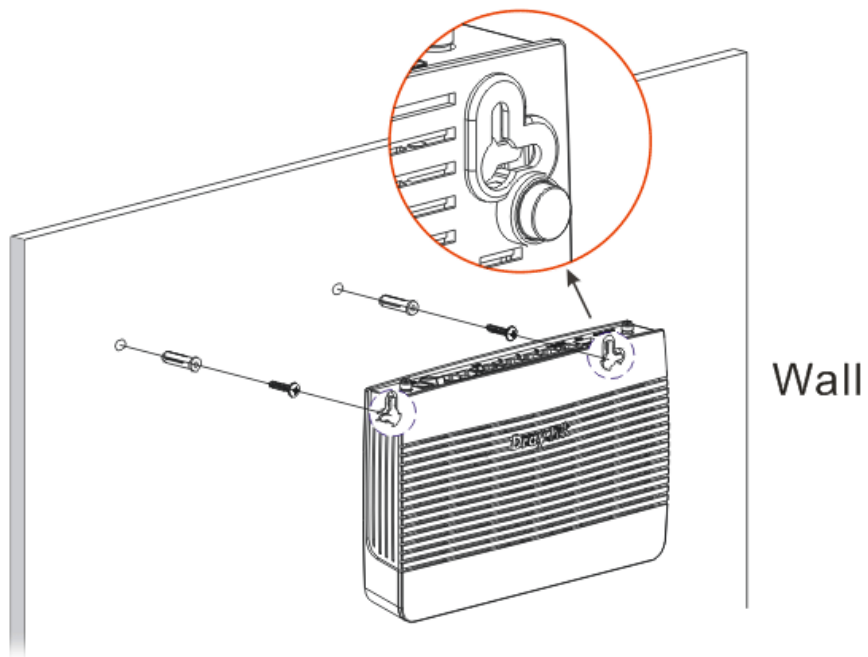

Note

The recommended drill diameter shall be 6.5mm (1/4").

4. When you finished about procedure, the router has been mounted on the wall firmly.

5. Software Configuration

To access Internet, please finish basic configuration after completing the hardware installation.

5.1 Check the DSL Link State

1. Connect the DSL line to Vigor Router and wait for a moment.
2. Login Vigor router WUI.
3. Check if Vigor router can get "SHOWTIME" with the DSL line via Online Status page.

If Vigor Router can get SHOWTIME with the DSL line, then you could go to 5.2 Quick Start Wizard for setting up the Internet Access settings.

Online Status

| Physical Connection | | System Uptime: 1day 5:29:14 | | | |
|---|----------|-----------------------------|----------------|---------------------|-----------------------|
| IPv4 | | IPv6 | | | |
| LAN Status | | | | | |
| IP Address | | TX Packets | RX Packets | Router Primary DNS: | Router Secondary DNS: |
| 192.168.1.1 | | 5,620 | 15,414 | 8.8.8.8 | 8.8.4.4 |
| WAN 1 Status >> Dial PPPoE | | | | | |
| Enable | Line | Name | Mode | Up Time | |
| Yes | VDSL2 | | PPPoE | 00:00:00 | |
| IP | GW IP | TX Bytes | TX Rate(bps) | RX Bytes | RX Rate(bps) |
| --- | --- | 0 (B) | 0 | 0 (B) | 0 |
| WAN 2 Status | | | | | |
| Enable | Line | Name | Mode | Up Time | |
| No | Ethernet | | --- | 00:00:00 | |
| IP | GW IP | TX Bytes | TX Rate(bps) | RX Bytes | RX Rate(bps) |
| --- | --- | 0 (B) | 0 | 0 (B) | 0 |
| WAN 3 Status | | | | | |
| Enable | Line | Name | Mode | Up Time | Signal |
| Yes | USB | | --- | 00:00:00 | - |
| IP | GW IP | TX Bytes | TX Rate(bps) | RX Bytes | RX Rate(bps) |
| --- | --- | 0 (B) | 0 | 0 (B) | 0 |
| Line 1 Information (VDSL2 Firmware Version: 779517_A/B/C) | | | | | |
| Profile | State | UP Speed | Down Speed | SNR Upstream | SNR Downstream |
| 30A | SHOWTIME | 97,861 (Kbps) | 101,058 (Kbps) | 5 (dB) | 23 (dB) |

If Vigor Router cannot get SHOWTIME with the line,

| | | | | | |
|---|----------|----------|--------------|--------------|----------------|
| --- | --- | 0 (B) | 0 | 0 (B) | 0 |
| WAN 3 Status | | | | | |
| Enable | Line | Name | Mode | Up Time | Signal |
| Yes | USB | | --- | 00:00:00 | - |
| IP | GW IP | TX Bytes | TX Rate(bps) | RX Bytes | RX Rate(bps) |
| --- | --- | 0 (B) | 0 | 0 (B) | 0 |
| Line 1 Information (VDSL2 Firmware Version: 779517_A/B/C) | | | | | |
| Profile | State | UP Speed | Down Speed | SNR Upstream | SNR Downstream |
| | TRAINING | 0 (Kbps) | 0 (Kbps) | 0 (dB) | 0 (dB) |

please:

- Select the other modem code via WAN General Setup page (WAN>>General Setup>>WAN1) and test if the one can get SHOWTIME with the line.

WAN >> General Setup

WAN 1

| | |
|-----------------|----------------------|
| Enable: | Yes ▾ |
| Display Name: | <input type="text"/> |
| Physical Mode: | ADSL |
| DSL Mode: | Auto ▾ |
| DSL Modem Code: | Default ▾ |

- Or, download the other firmware from DrayTek Website (www.draytek.com).

DrayTek provides several firmware files. Each firmware has 2 different DSL modem codes.

When the used modem code cannot get SHOWTIME, please try the different DSL modem codes in other firmware files and see if it can get SHOWTIME with your line.

5.2 Quick Start Wizard

The **Quick Start Wizard** is designed for you to easily set up your router for Internet access. You can directly access the **Quick Start Wizard** via Web Configurator.

Make sure your PC connects to the router correctly.

Open a web browser on your PC and type <http://192.168.1.1>. A pop-up window will open to ask for username and password. Please type "admin/admin" as the Username/Password and click **Login**.



Note

You may either simply set up your computer to get IP dynamically from the router or set up the IP address of the computer to be the same subnet as the default IP address of Vigor router 192.168.1.1.

Now, the Main Screen will pop up. Click Wizards>>Quick Start Wizard.

System Information

| | | | |
|------------------|-------------------|-----------------|--------------------------|
| Model Name | Vigor2762Vac | System Up Time | 45:48:04 |
| Router Name | DrayTek | Current Time | Sun Jan 02 2000 21:47:37 |
| Firmware Version | 3.9.2-STD | Build Date/Time | Nov 26 2019 11:47:36 |
| DSL Version | 07-07-06-0D-0D-07 | LAN MAC Address | 00-1D-AA-08-F5-20 |

IPv4 LAN Information

| LAN1 | IP Address | DHCP | LAN2 | IP Address | DHCP |
|------------------|----------------|------|------|----------------|------|
| IP Routed Subnet | 192.168.0.1/24 | v | | 192.168.2.1/24 | v |

IPv4 Internet Access

| WAN1 | Line / Mode | IP Address | MAC Address | Up Time |
|------|----------------|--------------|-------------------|----------|
| WAN1 | ADSL / PPPoE | Disconnected | 00-1D-AA-08-F5-21 | 00:00:00 |
| WAN2 | Ethernet / --- | Disconnected | 00-1D-AA-08-F5-22 | 00:00:00 |
| WAN3 | USB / --- | Disconnected | 00-1D-AA-08-F5-23 | 00:00:00 |

Interface

| | |
|--------|---|
| DSL | Connected : Down Stream : 0Kbps / Up Stream : 0Kbps |
| WAN | Connected : 0 @WAN1 @WAN2 @WAN3 |
| LAN | Connected : 0 @Port1 @Port2 @Port3 @Port4 |
| WLAN | Connected : 0 |
| WLAN5G | Connected : 0 |
| USB | Connected : 0 @USB 1 @USB 2 |

Security

| | | |
|---------|---|----------------------------------|
| VPN | Connected : 0 | Remote Dial-in User / LAN to LAN |
| MyVigor | Activate : 2, Web Content Filter, DrayDNS License | |
| DNS | Attack Defeated : | |



Note

The home page will change slightly in accordance with the router you have.

The first screen of Quick Start Wizard is entering login password. After typing the password, please click Next.

Quick Start Wizard

Enter login password

Please enter an alpha-numeric string as your Password (Max 23 characters).

Old Password

New Password

Confirm Password

On the next page as shown below, please select the WAN interface that you use. If DSL interface is used, please choose WAN1; if Ethernet interface is used, please choose WAN2; if 3G USB modem is used, please choose WAN3. Then click **Next** for next step. WAN1, WAN2 and WAN3 will bring up different configuration page. Here, we take **WAN1 (ADSL/VDSL2)** as an example.

Quick Start Wizard

WAN Interface

| | |
|-----------------------------|---|
| WAN Interface: | WAN1 ▾ |
| Display Name: | <input type="text"/> |
| Physical Mode: | ADSL / VDSL2 |
| Physical Type: | Auto negotiation ▾ |
| VLAN Tag insertion (ADSL): | Disable ▾ |
| VLAN Tag insertion (VDSL2): | Enable ▾ |
| Tag value | <input type="text" value="0"/> (0~4095) |
| Priority | <input type="text" value="0"/> (0~7) |

On the next page as shown below, please select the appropriate protocol according to the information from your ISP. For example, you should select PPPoE mode if the ISP provides you PPPoE interface. Then click **Next** for next step.

PPPoE/PPPoA

1. Choose **WAN1** as WAN Interface and click the **Next** button; you will get the following page.

Quick Start Wizard

Connect to Internet

WAN 1

Protocol: PPPoE / PPPoA ▾

For ADSL Only:

Encapsulation: PPPoE LLC/SNAP ▾

VPI:

VCI:

Fixed IP: Yes No(Dynamic IP)

IP Address:

Subnet Mask:

Default Gateway:

Primary DNS:

Second DNS:

2. After finished the above settings, simply click Next.

Quick Start Wizard

Set PPPoE / PPPoA

| | |
|-------------------------|---|
| WAN 1 | |
| Service Name (Optional) | <input type="text" value="2762"/> |
| Username | <input type="text" value="84005755@hinet.net"/> |
| Password | <input type="password" value="*****"/> |
| Confirm Password | <input type="password" value="*****"/> |

3. Please manually enter the Username/Password provided by your ISP. Then click Next for viewing summary of such connection.

Quick Start Wizard

Please confirm your settings:

| | |
|---------------------------|--------------|
| WAN Interface: | WAN1 |
| Physical Mode: | ADSL / VDSL2 |
| VPI: | 0 |
| VCI: | 33 |
| Protocol / Encapsulation: | PPPoE / LLC |
| Fixed IP: | Yes |
| IP Address: | 192.16.20.66 |
| Subnet Mask: | |
| Default Gateway: | |
| Primary DNS: | 8.8.8.8 |
| Secondary DNS: | 8.8.4.4 |

4. Click Finish. A page of Quick Start Wizard Setup OK!!! will appear. Then, the system status of this protocol will be shown.
5. Now, you can enjoy surfing on the Internet.

MPoA / Static or Dynamic IP

1. Choose WAN1 as WAN Interface and click the Next button; you will get the following page.

Quick Start Wizard

Connect to Internet

| | |
|-----------------------|---|
| WAN 1 | |
| Protocol | MPoA / Static or Dynamic IP ▼ |
| For ADSL Only: | |
| Encapsulation | 1483 Bridged IP LLC ▼ |
| VPI | 0 <input type="button" value="Auto detect"/> |
| VCI | 33 |
| Fixed IP | <input checked="" type="radio"/> Yes <input type="radio"/> No(Dynamic IP) |
| IP Address | 192.16.20.86 |
| Subnet Mask | 255.255.255.0 |
| Default Gateway | 192.16.20.1 |
| Primary DNS | 8.8.8.8 |
| Second DNS | 8.8.4.4 |

2. Please type in the IP address/mask/gateway information originally provided by your ISP. Then click Next for viewing summary of such connection.

Quick Start Wizard

Please confirm your settings:

| | |
|---------------------------|-----------------|
| WAN Interface: | WAN1 |
| Physical Mode: | ADSL / VDSL2 |
| VPI: | 0 |
| VCI: | 33 |
| Protocol / Encapsulation: | 1483 Bridge LLC |
| Fixed IP: | Yes |
| IP Address: | 192.16.20.86 |
| Subnet Mask: | 255.255.255.0 |
| Default Gateway: | 192.16.20.1 |
| Primary DNS: | 8.8.8.8 |
| Secondary DNS: | 8.8.4.4 |

3. Click Finish. A page of Quick Start Wizard Setup OK!!! will appear. Then, the system status of this protocol will be shown.
4. Now, you can enjoy surfing on the Internet.

6. Customer Service

If the router cannot work correctly after trying many efforts, please contact your dealer/DrayTek for further help right away. For any questions, please feel free to send e-mail to "support@draytek.com".

Be a Registered Owner

Web registration is preferred. You can register your Vigor router via <http://www.draytek.com>.

Firmware & Tools Updates

Due to the continuous evolution of DrayTek technology, all routers will be regularly upgraded. Please consult the DrayTek web site for more information on newest firmware, tools and documents.

<http://www.draytek.com>