



MPC-2190 Series Quick Installation Guide

Second Edition, March 2015

1. Overview

MPC-2190 panel computers feature advanced Intel processors—3rd generation Ivy Bridge Core or Celeron—matched to 4 GB of system memory, delivering a reliable, high-performance platform of wide versatility for use in industrial marine environments. With its RS-232/422/485, NMEA 0183, and Gigabit Ethernet LAN ports, the MPC-2190 panel computer supports a wide variety of serial- and marine-specific interfaces alongside high speed IT communications and native Ethernet redundancy.

The MPC-2190 series comes with a range of standard display enhancements useful in industrial environments (including 0 to 100% full range dimming, 178°/178° wide viewing angles, optional optical bonding, and/or a multi-touch screen), as well as Moxa's SavvyTouch display controls.

2. Package Checklist

Before installing the MPC-2190, verify that the package contains the following items:

- MPC-2190 panel computer
- 2 keys for the removable storage trays
- 1 2-pin terminal block for DC power input
- 2 5-pin terminal blocks for NMEA 0183 v2 interfaces
- Hard disk drive installation kit
- Documentation and driver DVD
- Quick installation guide (printed)
- Warranty card

NOTE: Please notify your sales representative if any of the above items are missing or damaged.

3. Hardware Installation

Bottom View

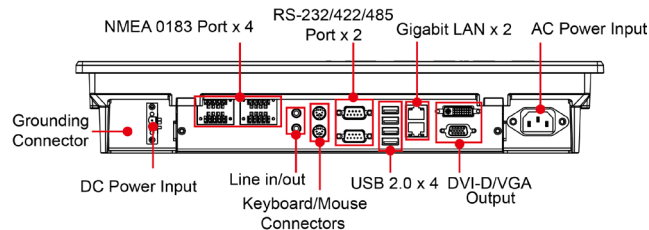



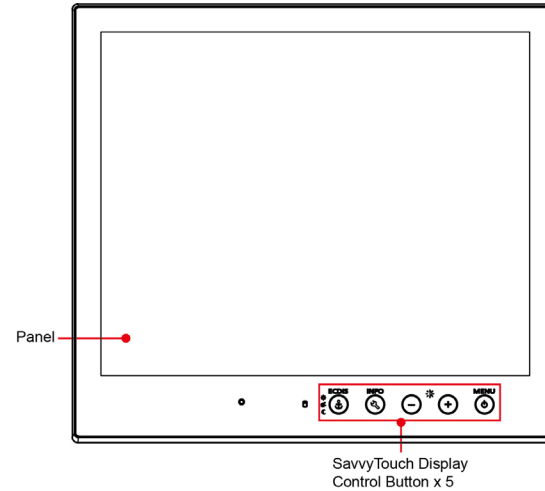

Front View



SavvyTouch Display Control Buttons

The following table describes the SavvyTouch display controls on the front surface of the MPC-2190. These intelligent controls will light up with a simple hand-wave above the area of the screen where they are located.

Name	Displayed Color	Control Function / Color Legend
 Power	Green	Power is on and functioning normally
	Red	Power standby and system shut down
	Off	Power is off.
 Brightness	White	+ : To increase brightness of panel - : To decrease brightness of panel
	 Info	Off
 Storage	Red (on)	Storage drive is functioning properly
	Red (blinking)	Drive is accessing or writing data
	Off	Drive is offline.
 Display mode (ECDIS models only)	White	Displays the brightness mode
	Off	Panel brightness out of ECDIS standard range

Installing the MPC-2190 Series

Desktop

The MPC-2190 comes with optional brackets that allow you to install the panel computer on a horizontal surface, such as a desktop. Three round screws are required for each bracket. Place the panel computer panel-side down on a clean, flat, non-scratch-surface. See the figure below for details about screw specifications, locations, and their torque value.

To protect the computer from overheating, leave some ventilation space between the MPC-2190 and other equipment. Do not leave the panel lying on its back equipment, nor put objects on the computer, as this might damage internal components.

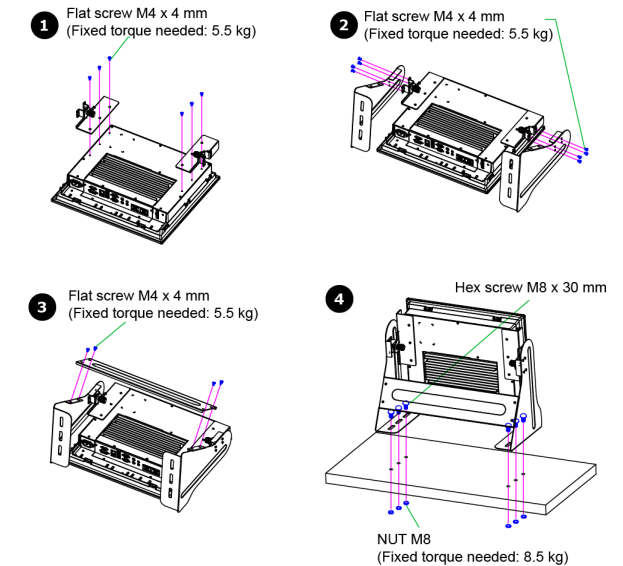

NOTE: These desktop brackets are intended for temporary use when conducting lab tests, and should not be used as a permanent mounting method.

Wall Mounting

The MPC-2190 Series comes with 14 optional clamp mounts that allow for installation onto a wall (where space has been cut out to accommodate the rest of the hardware) or into computing stations where a flush mount is desired. **The maximum thickness of a surface to which the computer may be clamped is 11 mm.** For a secure mounting, all 14 clamps must be used. The clamp arms are fastened into slots on all four sides of the MPC-2190. Use the short M4 SUS screws to fasten the clamp arms to the MPC-2190 mounting slots, as shown in the magnified inset in the diagram just below. Next, use the clamps to fasten the computer

to its mounting point; please note the torque value that is shown in the figure inset, at the top of the next page.

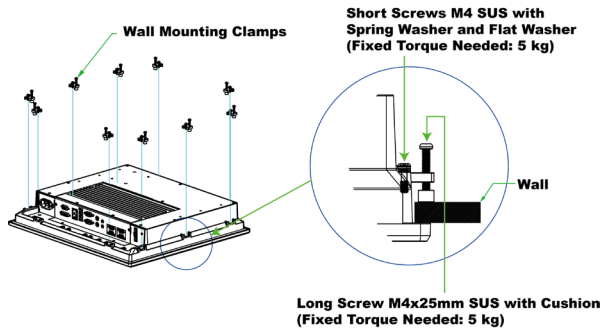

VESA Mounting

The MPC-2190 may also come with an optional VESA mounting kit. Six flat screws and four round screws are required to fasten the VESA mounting bracket. See the figure below for detailed screw specifications and torque values.

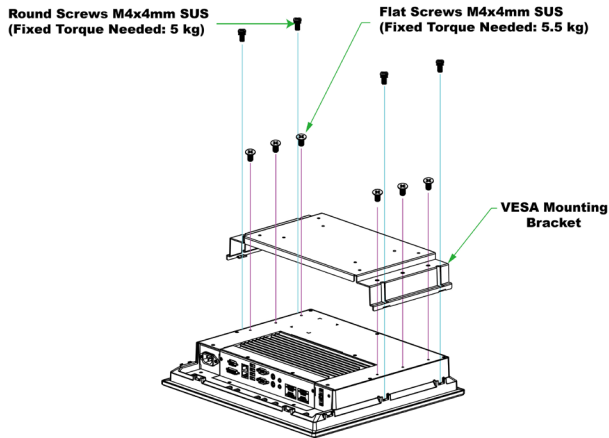

An additional four screws (not included in the kit) are required to mount the computer on a VESA rack. For this purpose, use M6 screws with a length between 10 and 12 mm.

4. Connector Description

Extending the Display

The MPC-2190 comes with both standard VGA (DB15) and DVI-D (DB29) interfaces (located on the bottom of the shell) which may be used to simultaneously extend the display across two monitors.

Connecting to a Keyboard and Mouse

The MPC-2190 Series comes with two PS/2

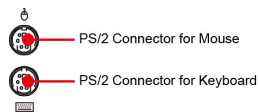

connectors located on the bottom surface, for connecting a keyboard and a mouse.

Serial Ports

The MPC-2190 offers two software-selectable RS-232/422/485 serial ports over a DB9 connector. Refer to the MPC-2190 User's Manual for the details on serial port configuration. The pin assignments for the ports are shown in the following table:

Pin	RS-232	RS-422	RS-485 (4-wire)	RS-485 (2-wire)
1	DCD	TxDA(-)	TxDA(-)	-
2	RxD	TxDB(+)	TxDB(+)	-
3	TxD	RxDB(+)	RxDB(+)	DataB(+)
4	DTR	RxDA(-)	RxDA(-)	DataA(-)
5	GND	GND	GND	GND
6	DSR	-	-	-
7	RTS	-	-	-
8	CTS	-	-	-

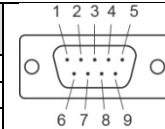

Ethernet Ports

The pin assignments for the two Fast Ethernet 100/1000 Mbps RJ45 ports are shown in the following table:

Pin	100 Mbps	1000 Mbps
1	ETx+	TRD(0)+
2	ETx-	TRD(0)-
3	ERx+	TRD(1)+
4	-	TRD(2)+
5	-	TRD(2)-
6	ERx-	TRD(1)-
7	-	TRD(3)+
8	-	TRD(3)-

Refer to the following table for a description of the LAN indicators:

LAN (on connectors)	Green	100 Mbps Ethernet mode
	Yellow	1000 Mbps (Gigabit) Ethernet mode
	Off	No activity / 10 Mbps Ethernet mode

NMEA Ports

The MPC-2190 comes with eight NMEA ports on the bottom surface. The pin assignments are shown in the figure at right.

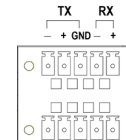

Audio Interface

The MPC-2190 comes with line-in and line-out audio jacks, allowing users to connect a speaker system, an earphone, or a microphone.

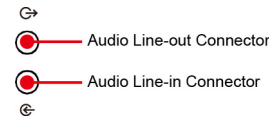

USB Ports

Four USB 2.0 ports are available on the bottom surface. Use these ports to connect mass storage drives and other peripherals.

HDD Installation Brackets

The MPC-2190 comes with two storage drive installation brackets where a 2.5" SATA mass storage drive may be installed. Refer to the hardware manual for detailed installation instructions.

Real Time Clock

The real time clock (RTC) is powered by a lithium battery. We strongly recommend that you do not replace the lithium battery without help from a qualified Moxa support engineer. If you need to change the battery, contact the Moxa RMA service team at http://www.moxa.com/rma/about_rma.aspx.



ATTENTION

There is a risk of explosion if the clock's lithium battery is replaced with an incompatible battery.

5. Powering on/off the MPC-2190

To power on the panel computer you may either connect power by connecting the **Terminal Block to Power Jack Converter** to the terminal block and then connect a power adapter, or you may connect the computer to an AC power source using the power cord. After the power source is connected, touch the **Menu** button to turn the computer on. It takes about 10 to 30 seconds for the system to boot up.

To power off the MPC-2190 Series, touch the **MENU** button for 4 seconds; depending on your OS's power management settings you may enter **standby**, **hibernation**, or **system shutdown** mode. If you encounter technical problems, touch and hold the **MENU** button for 10 seconds to force a hard shutdown of the system.

Grounding the MPC-2190 Series

Proper grounding and wire routing help to limit the effects of noise from electromagnetic interference (EMI). Run the ground connection from the ground screw to the grounding surface prior to connecting the power source.



The Americas: +1-714-528-6777 (toll-free: 1-888-669-2872)
 Europe: +49-89-3 70 03 99-0
 Asia-Pacific: +886-2-8919-1230
 China: +86-21-5258-9955 (toll-free: 800-820-5036)

© 2015 Moxa Inc. All rights reserved.